



**SPECIFICATION
GUIDE 2026**

**Choice Select® &
Choice Essentials®**

PRODUCT CODES

3 CABINETSRY CODES

CHOICE SELECT®

5 DOOR STYLES

6 CONSTRUCTION

7 WALL CABINETS

9 BASE CABINETS

12 TALL CABINETS

13 BATHROOM VANITIES

14 PANELS & SKINS

16 MOLDINGS & TRIM

CHOICE ESSENTIALS®

18 DOOR STYLES

19 CONSTRUCTION

20 WALL CABINETS

22 BASE CABINETS

24 TALL CABINETS

25 BATHROOM VANITIES

26 PANELS & SKINS

27 MOLDINGS & TRIM

ACCESSORIES & RESOURCES

30 DECORATIVE HARDWARE

31 TOUCH UPS

32 STORAGE ACCESSORIES

33 GLIDES & HINGES

34 SAMPLES

35 MADE TO ORDER

36 MARKETING & LITERATURE

CARE & COVERAGE

38 CLEANING, CARING & MAINTENANCE

39 PRODUCT & FINISH INFORMATION

40 LIMITED LIFETIME WARRANTY

41 1-YEAR LIMITED WARRANTY

CONNECT WITH US

42 ONLINE

43 IN-PERSON

TOOLS & SUPPORT

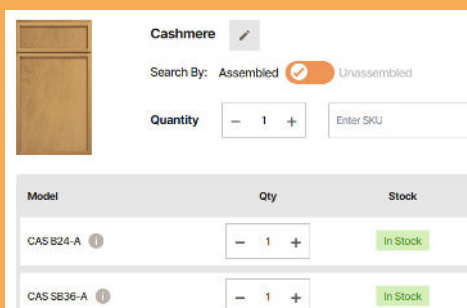

WEBSITE

A single destination for product details, inspiration and dealer resources. Explore door styles by profile and finish, browse design ideas, and find FAQs, care tips, and accessories.

LIVE CUSTOMER SUPPORT

Our Customer Support team is here to help with orders, product questions, order status, delivery tracking and billing.

24/7 ACCESS

Choice Cabinet dealers can access our web store and cloud-based ordering system anytime to:

- Place and track orders
- Access catalogs & sales tools
- Download marketing assets
- Order samples and displays

UNASSEMBLED CABINETRY CODES

Naming starts with the door style code followed by the item code.

FMT UP1884



DETAILS & ORDERING

- Standard lead time for unassembled orders to ship is typically one week, however this can vary
- Assembly costs will vary for each cabinet based on complexity

ASSEMBLED CABINETRY CODES

Naming starts with the door style code followed by the item code. You must add an "-A" to the end of the item code:

FMT UP1884-A

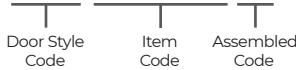

DETAILS & ORDERING

- Standard lead time for assembled orders to ship is typically two to three weeks, however this can vary
- Assembly costs will vary for each cabinet based on complexity
- Due to LTL and freight classifications, shipping costs for assembled cabinetry can be considerably higher than RTA cabinetry and shipments
- Please review Terms & Conditions when ordering assembled cabinetry
- If you have any additional questions or concerns regarding the assembled cabinetry program, please contact your sales representative

MODIFIED CABINETRY CODES

Naming starts with the door style code followed by the item code:

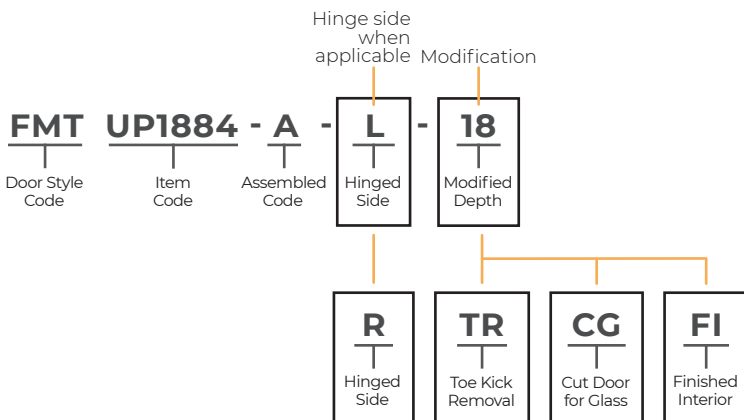

DETAILS



- You must add a "-###", "-TR", "-CG" or "-FI" to the end of the item code
- Modification of cabinet depth is available in 3" increments only; modified depth drawer boxes will have no dovetail in the back of drawer
- Modification costs will vary for each cabinet based on complexity
- Some modifications require the cabinet to be assembled at time of modification

Choice Select

DOOR STYLES

All Choice Select® have: full overlay, 5-piece drawer front, and mortise and tenon.

DOOR CONSTRUCTION KEY

-  Solid Wood
-  Veneered MDF

FREMONT (FMT)



- White painted finish
- MDF center panel

GRAPHITE (GRA)



- Gray stained finish
- Veneered MDF center panel

FROST (FRO)



- White painted finish
- MDF center panel

STERLING (STE)



- Gray painted finish
- MDF center panel

DOVE (DOV)



- White painted finish
- MDF center panel

CASHMERE (CAS)



- Natural stain finish
- Veneered MDF center panel

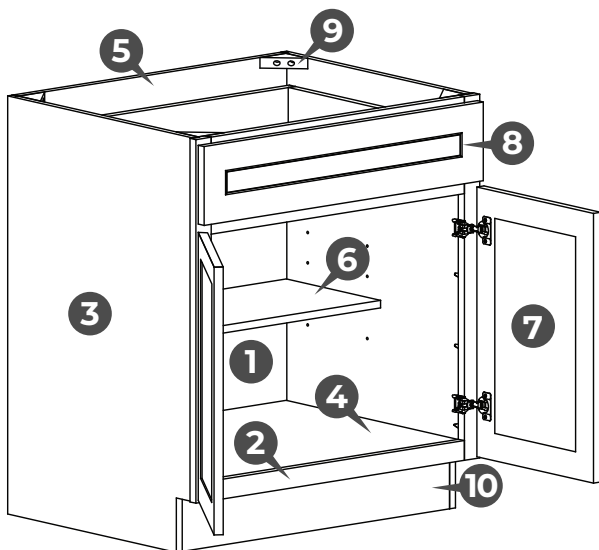
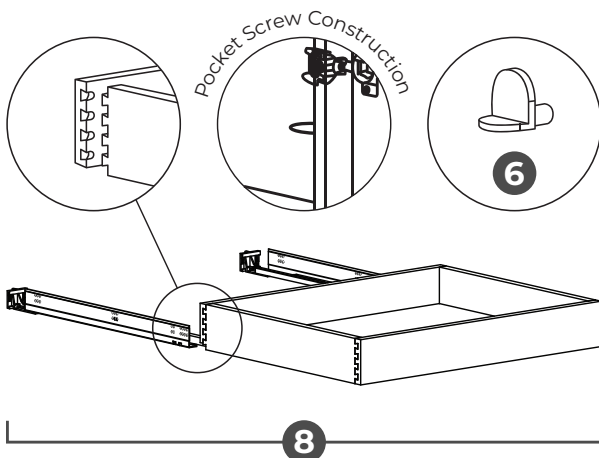
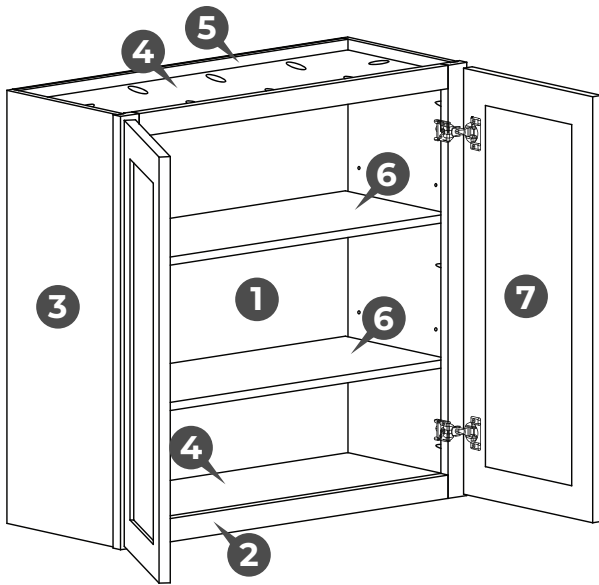

CONSTRUCTION

- 1** Natural hardwood interior
- 2** 3/4" solid hardwood face frame
- 3** 1/2" veneered plywood end panels with matching exterior finish
- 4** 1/2" veneered plywood captured floor and ceiling panels with natural finish
- 5** 5/8" framed plywood back
- 6** 3/4" veneered plywood half depth, adjustable shelving with metal shelf clips
- 7** Full overlay stile and rail with veneered or painted MDF center panel and 6-way adjustable, concealed soft-close hinges
- 8** Full overlay 5-piece drawer front with 1/2" finger jointed hardwood dovetailed drawer box, 3/8" veneered plywood drawer bottom, and full extension under-mount soft-close drawer glides
- 9** 3/4" solid wood corner braces
- 10** 4 1/2" high and 1/2" thick unfinished veneered plywood toe kick

LIFETIME LIMITED WARRANTY

EPA COMPLIANCE



WALL CABINET CODES

FMT W3012

Door Style Code: **FMT** Cabinet Code: **W3012**

Letter represents type of cabinet: **W** (Wall Cabinet)

30 (Width) **12** (Height)

24 (Depth)

If the depth is different from the Wall Cabinet standard of 12", it is represented by a third set of numbers.

DETAILS

- Wall cabinetry is 12" deep unless otherwise noted

Wall Bridge Single Door 12" High W1812

- No shelf

Wall Bridge Double Door 12" High W3012
W3312
W3612

- No shelf

Wall Bridge Double Door 15" High W2415
W3015
W3315
W3615

- No shelf

Wall Bridge Double Door 18" High W2418
W3018
W3318
W3618

- No shelf

Wall Bridge Double Door 21" High W3021

- No shelf

Wall Bridge Double Door 24" High W2424
W3024
W3324
W3624

- One adjustable shelf

Wall Bridge Refrigerator Double Door 24" Deep W331224
W331824
W332424*
W361224
W361524
W361824
W362424*

- No shelf
- For installation between a combination of cabinets, refrigerator panels, or two walls for support
- * One adjustable shelf

Wine Rack WR3015

- Finished interior
- Holds thirteen standard sized 750ml wine bottles
- Horizontal or vertical use
- Can be used in a wall or base application

Wine Rack WR1818

- Finished interior
- Holds sixteen standard sized 750ml wine bottles
- Stackable

Wall Single Door 30" High

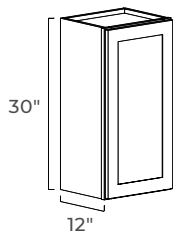

- Two adjustable shelves

W0930
W1230
W1530
W1830
W2130

Wall Single Door 36" High

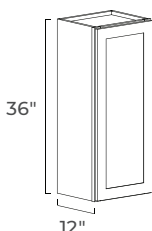

- Two adjustable shelves

W0936
W1236
W1536
W1836
W2136

Wall Single Door 42" High

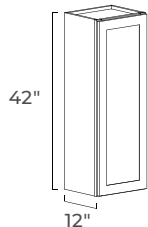

- Three adjustable shelves

W0942
W1242
W1542
W1842
W2142

Wall Double Door 30" High

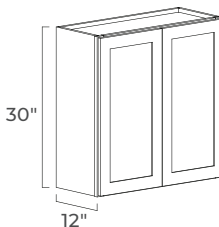

- Two adjustable shelves

W2430
W2730
W3030
W3330
W3630

Wall Double Door 36" High

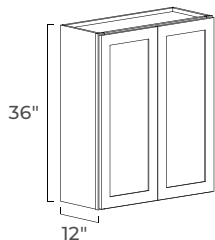

- Two adjustable shelves

W2436
W2736
W3036
W3336
W3636

Wall Double Door 42" High

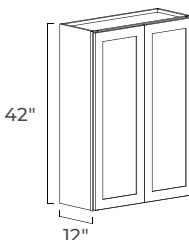

- Three adjustable shelves

W2442
W2742
W3042
W3342
W3642

Angled Triangle Wall

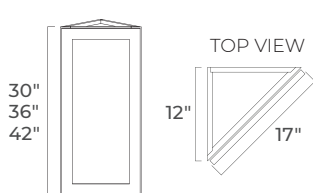

- Pre-assembled
- Two adjustable shelves
- * Three adjustable shelves

ATW1230
ATW1236
ATW1242*

Wall Easy Reach

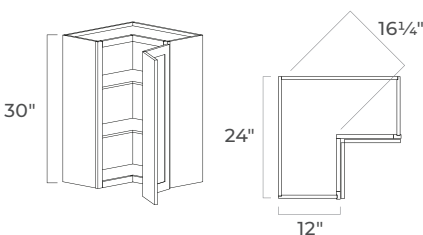

- Bi-folding door
- Two adjustable shelves
- Soft-close not available

WEZR2430

Wall Diagonal Corner

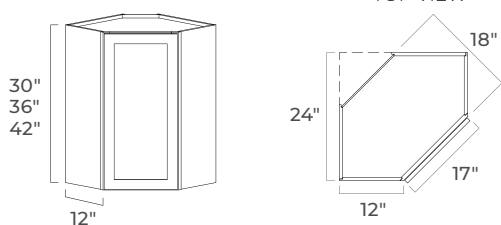

- 24" wide
- Two adjustable shelves
- * Three adjustable shelves

WDC2430
WDC2436
WDC2442*

Wall Diagonal Corner

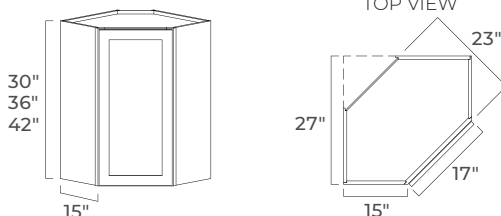

- 27" wide
- Two adjustable shelves
- * Three adjustable shelves

WDC2730
WDC2736
WDC2742*

Wall Microwave

MC3018

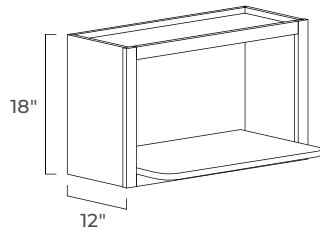

INTERIOR DIMENSIONS

SKU	WIDTH	HEIGHT	DEPTH
MC3018	28 1/4"	14 1/4"	10 5/8"

FRAME OPENING WITH SHELF DIMENSIONS

SKU	WIDTH	HEIGHT	DEPTH
MC3018	26 3/4"	14"	17 1/2"

- For a countertop style microwave
- Finished interior
- One finished shelf: 5/8" thick, 18" deep
- For installation between two cabinets or a cabinet and a wall

Wall Single Door Blind Corner

WBC2830
WBC2836
WBC2842*

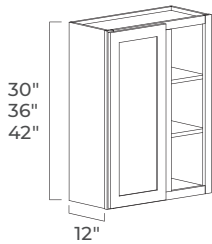

FACE FRAME OPENING DIMENSIONS

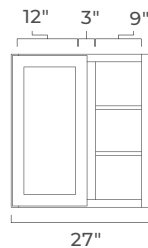

INSTALLATION DIAGRAM

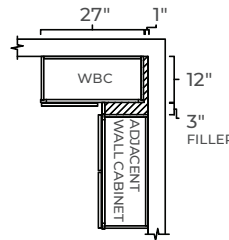

- 27" wide
- Two adjustable shelves
- Requires 1" pull from adjacent wall (28" total installed width)
- Hinged on center stile of face frame; can be flipped for left or right application during assembly
- Same size door and opening as W1530, W1536, and W1542
- 3" wall filler included
- * Three adjustable shelves

Wall Single Door Blind Corner

WBC3630
WBC3636
WBC3642*

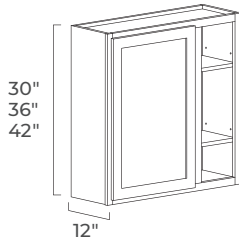

FACE FRAME OPENING DIMENSIONS

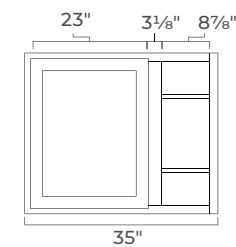

INSTALLATION DIAGRAM

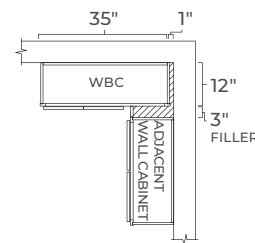

- 35" wide
- Two adjustable shelves
- Requires 1" pulls from adjacent wall (36" total installed width)
- Hinged on center stile of face frame; can be flipped for left or right application during assembly
- 3" wall filler included
- * Three adjustable shelves

Wall False Door

WFD1230
WFD1236
WFD1242

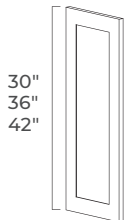

ACTUAL DOOR DIMENSIONS

SKU	WIDTH	HEIGHT	DEPTH
WFD1230	11 1/2"	29 1/2"	3/4"
WFD1236	11 1/2"	35 1/2"	3/4"
WFD1242	11 1/2"	41 1/2"	3/4"

- Matches ordered door style
- 3/4" thick, decorative panel for finishing sides of exposed cabinetry
- Flat back; requires a WSK to sit flush on cabinet side

Wall Filler

WF342
WF642

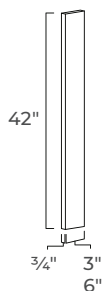

- 3/4" thick, solid wood
- Finished front and long sides
- Cut width and height to fit as needed

BASE CABINET CODES

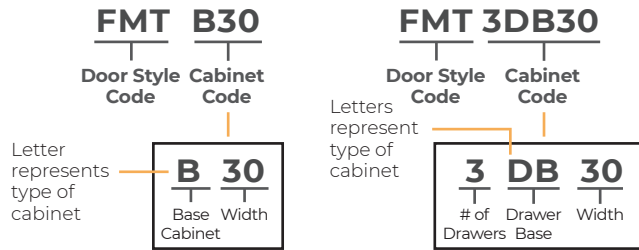

DETAILS

- Base cabinetry is 24" deep unless otherwise noted
- Single door base cabinetry is hinged on the right side of the face frame and can be flipped in the field as necessary

Base Full Height

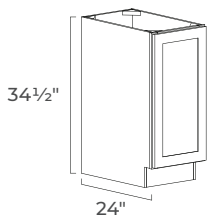

- One adjustable half shelf

BFH09
BFH12
BFH15
BFH18
BFH21

Base Single Door

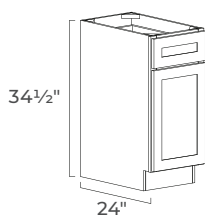

- One adjustable half shelf

B09
B12
B15
B18
B21

Three Drawer Base

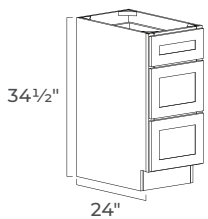

- One standard depth drawer
- Two deep drawers
- Top drawer aligns with standard base cabinetry

3DB12
3DB15
3DB18
3DB21
3DB24
3DB27
3DB30
3DB33
3DB36

Base Double Door

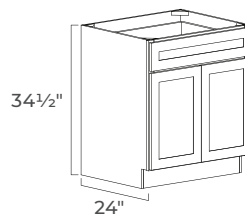

- One adjustable half shelf

B24
B27
B30
B33
B36

Two Drawer Base

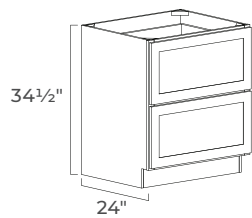

- Two deep drawers

2DB30
2DB36

Sink Base

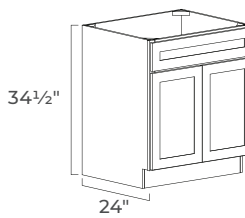

- False drawer front

SB30
SB33
SB36

Farmhouse Sink Base

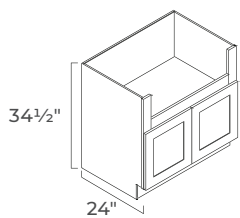

- 36" wide
- Fits most 30–33" wide farmhouse style sinks
- Face frame can be trimmed in field per sink specifications
- Opening: 30" W x 8" H (width and height can be increased independently up to 33" W x 11" H)
- Same size doors as W3618

FSB36

Microwave Base

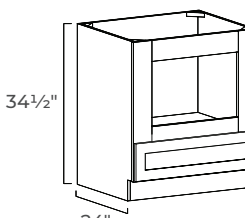

- 29 1/2" wide
- 11" high drawer
- Finished interior
- Opening*: 21" W x 14" H (width and height can be increased independently up to 27" W x 18" H)
- * 4 1/2" pocket frame stiles can be modified as necessary

MWB30

Angled Full Height Base

AFHB12

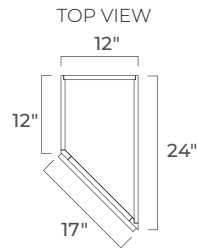
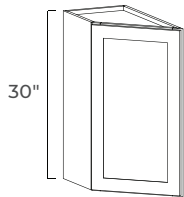

- One adjustable shelf
- Full-height door
- Hinged on center stile of face frame; can be flipped for left or right application during assembly
- Toe kick not included
- Installer must build toe kick support and conceal with TK8

Lazy Susan

LS33-L

LS33-R

LS36-L

LS36-R*

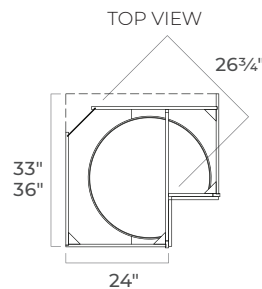
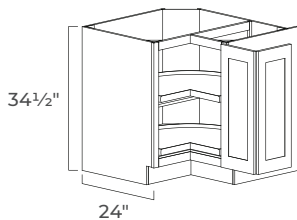

- Full height, bi-folding door
- Two rotating pie-cut trays
- Trays: veneered plywood with solid wood perimeter lip
- Under-mount rotating bearings allow for independent rotation and full access to trays
- Soft-close not available
- Magnetic door catch attached
- LS36-R shown

Lazy Susan Diagonal Door

LS36DD

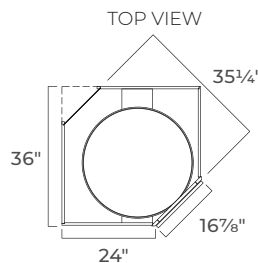
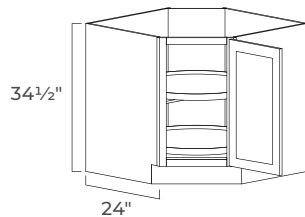

- Full height door
- Two rotating full circle trays
- Trays: veneered plywood with solid wood perimeter lip
- Under-mount rotating bearing allows for independent rotation and full access to trays

Base Blind Corner

BBC39

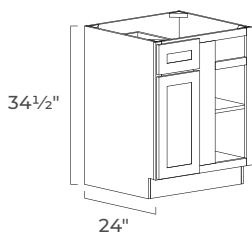

FACE FRAME OPENING DIMENSIONS

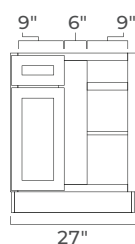

INSTALLATION DIAGRAM

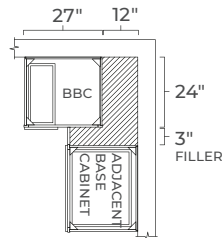

- 27" wide
- One adjustable shelf
- Requires 12" minimum pull from adjacent wall (39" total installed width)
- Hinged on center stile of face frame; door and drawer can be flipped for left or right application during assembly
- 3" filler included
- Same door, drawer, and door opening as B12

Base Blind Full Height

BBFH46-49

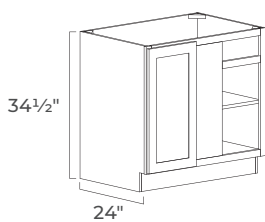

FACE FRAME OPENING DIMENSIONS

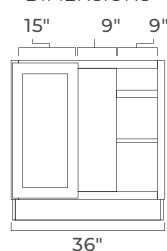

INSTALLATION DIAGRAM

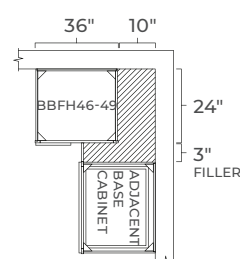

- 36" wide
- One adjustable shelf
- Requires 10" minimum pull from adjacent wall (46" total installed width)
- Hinged on center stile of face frame; can be flipped for left or right application during assembly
- 3" filler included
- Same door opening as B18

TALL CABINET CODES

FMT UP1884

Door Style Code Cabinet Code

Letters represent type of cabinet

UP 18 84

Tall Cabinet Width Height

DETAILS

- Tall cabinetry is 24" deep unless otherwise noted

Oven Cabinet

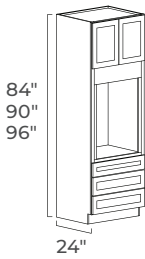

FRAME OPENING (MIN) DIMENSIONS

SKU	WIDTH	HEIGHT	DEPTH
OV3384	27"	28½"	22 ⁵ / ₈ "
OV3390	27"	28½"	22 ⁵ / ₈ "
OV3396	27"	28½"	22 ⁵ / ₈ "

FRAME OPENING (MAX) DIMENSIONS

SKU	WIDTH	HEIGHT	DEPTH
OV3384	31¼"	66½"	23 ³ / ₈ "
OV3390	31¼"	66"	23 ³ / ₈ "
OV3396	31¼"	66"	23 ³ / ₈ "

- No shelf in top section
- Three drawers in lower section
- Removable drawers and trimmable frame allow for larger appliances
- Drawer sizes: Top – 31" x 5½"; Bottom/Middle – 31" x 10¼"

- OV3384
- OV3390
- OV3396

Utility Pantry Single Door

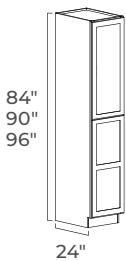

ADDITIONAL INFORMATION

SKU	UPPER DOOR HEIGHT	# OF UPPER SHELVES	# OF LOWER SHELVES
UP1884	29½"	ONE	TWO
UP1890	35½"	ONE	TWO
UP1896	41½"	TWO	TWO

- Lower door has center rail, creating two-panel door design
- Accepts 18" rollout trays (ACC ROT18 ordered separately)
- Magnetic door catch attached
- Universal bottom door height: 49¼"
- Pantry doors width: 17½"

- UP1884
- UP1890
- UP1896

Utility Pantry Double Door

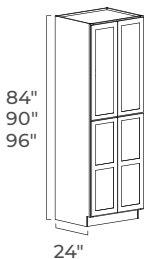

ADDITIONAL INFORMATION

SKU	UPPER DOOR HEIGHT	DOOR WIDTH	# OF UPPER SHELVES	# OF LOWER SHELVES
UP2484	29½"	11¾"	ONE	TWO
UP2490	35½"	11¾"	ONE	TWO
UP2496	41½"	11¾"	TWO	TWO
UP3084	29½"	14¾"	ONE	TWO
UP3090	35½"	14¾"	ONE	TWO
UP3096	41½"	14¾"	TWO	TWO

- Lower door has center rail, creating two-panel door design
- 24" wide pantry accepts 24" rollout trays (ACC ROT24 ordered separately)
- 30" wide pantry accepts 30" rollout trays (ACC ROT30 ordered separately)
- Magnetic door catch attached
- Universal bottom door height: 49¼"

- UP2484
- UP2490
- UP2496
- UP3084
- UP3090
- UP3096

Tall Filler

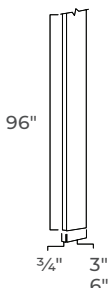

- ¾" thick, solid wood
- Finished front and sides
- Cut width and height to fit as needed

TF396

TF696

BATHROOM VANITY CODES

FMT VSB243421

Door Style Code

Cabinet Code

If the cabinet has drawers it's represented by a number in front of the style

3
of Drawers

Letters represent type of cabinet

VSB 24 34 21
Vanity Sink Base Width Height Depth

DETAILS

- Bathroom vanities are 34½" high and 21" deep unless otherwise noted

Vanity Sink Base

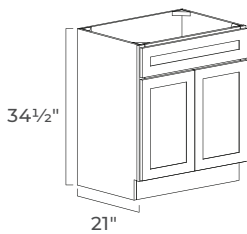

- No shelf
- For single bowl installation only
- Two doors; top drawer is a false drawer front
- Finished toe kick included (made to width)

VSB243421
VSB303421
VSB363421

Three Drawer Vanity Drawer Base

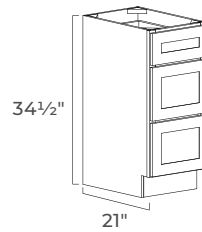

- One standard depth drawer
- Two deep drawers
- Top drawer aligns with standard base cabinetry
- Finished toe kick included (made to width)

3VDB123421
3VDB153421
3VDB183421

Vanity Combo: Two Drawer/One Door

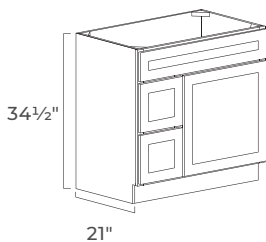

- No shelf
- For single bowl installation only
- Drawers always 12" wide
- Top drawer is a false drawer front
- Finished toe kick included (made to width)
- * V303421L shown

V303421L*
V303421R

Vanity Combo: Two Drawer/Two Door

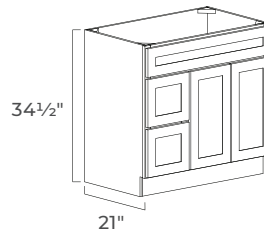

- No shelf
- For single bowl installation only
- Drawers always 12" wide
- Top drawer is a false drawer front
- Finished toe kick included (made to width)
- * V363421L shown

V363421L*
V363421R

Vanity Combo: Two Drawer/Three Door

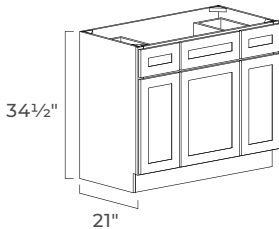

- No shelf
- For single bowl installation only
- Drawers always 12" wide
- Top middle drawer is a false drawer front
- Finished toe kick included (made to width)

V423421

Vanity Combo: Six Drawer/Two Door

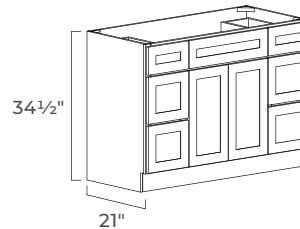

- No shelf
- For single bowl installation only
- Drawers always 12" wide
- Top middle drawer is a false drawer front
- Finished toe kick included (made to width)

V483421
V603421S

Vanity Combo: Three Drawer/Four Door

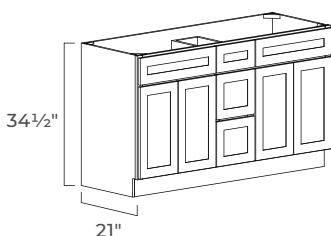

- No shelf
- For double bowl installation only
- Drawers always 12" wide
- Two top outside drawers are false drawer fronts
- Finished toe kick included (made to width)

V603421D

Bathroom Vanity Filler

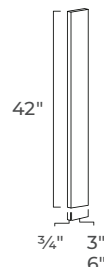

- ¾" thick, solid wood
- Finished front and sides
- Cut width and height to fit as needed

WF342
WF642

PANEL & SKIN CODES

FMT WSK1242

Door Style Code Product Code

Letters represent type of product

WSK 12 42
Wall Skin Width Height

When applicable add numbers for width and height

Base Skin

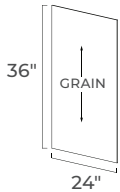

- 1/4" thick; one finished side
- For skinning sides of base cabinetry
- Cut width and height to fit
- Notch for toe kick as needed
- Install flush with cabinet frame
- Stained: Veneered plywood or MDF core construction
- Painted: MDF core construction

BSK

Wall Skin

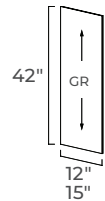

- 1/4" thick; one finished side
- For skinning sides of wall cabinetry
- Cut width and height to fit
- Install flush with cabinet frame
- Stained: Veneered plywood or MDF core construction
- Painted: MDF core construction

WSK1242

WSK1542

Tall Skin Beadboard

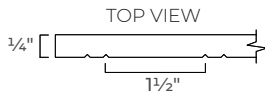
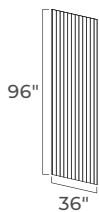

- 1/4" thick; one finished side
- For skinning exposed backs of peninsulas, islands, and other design applications
- Grain runs parallel with 96" sides

TSKB3696

Tall Skin



- 1/4" thick; one finished side
- For skinning sides of tall cabinetry
- Cut width and height to fit
- Notch for toe kick as needed
- Install flush with cabinet frame
- Stained: Veneered plywood or MDF core construction
- Painted: MDF core construction

TSK2496

Dishwasher Panel

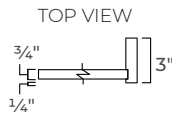
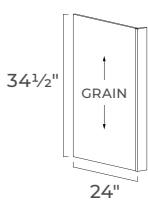

- 3/4" thick, veneered plywood, finished on outside
- Bored for assembly along one unfinished side
- 3" wide, 3/4" thick solid wood return filler, finished on front and sides
- For use next to a dishwasher

DWP

Refrigerator Panel

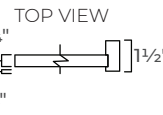
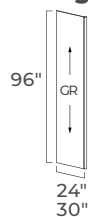

- 3/4" thick, veneered plywood, finished on both sides
- Bored for assembly along one side
- 1 1/2" wide, 3/4" thick solid wood return filler, finished on front and sides
- For use next to or flanking refrigerator to conceal sides & support wall cabinetry above

RP2496

RP3096

Back Skin

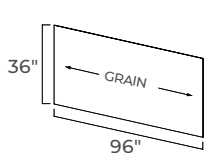

- 1/4" thick; one finished side
- For skinning exposed backs of peninsulas, islands, and other design applications
- Grain runs parallel with 96" sides

BS9636

Back Skin

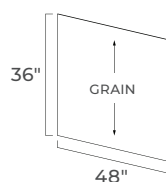

- 1/4" thick; one finished side
- For skinning exposed backs of peninsulas, islands, and other design applications

BS4836

Wall False Door



ACTUAL DOOR DIMENSIONS

SKU	WIDTH	HEIGHT	DEPTH
WFD1230	11 1/2"	29 1/2"	3/4"
WFD1236	11 1/2"	35 1/2"	3/4"
WFD1242	11 1/2"	41 1/2"	3/4"

- Matches ordered door style
- 3/4" thick, decorative panel for finishing sides of exposed cabinetry
- Flat back; requires a WSK to sit flush on cabinet side

WFD1230

WFD1236

WFD1242

Base False Door

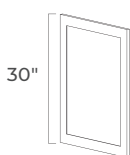

ACTUAL DOOR DIMENSIONS

SKU	WIDTH	HEIGHT	DEPTH
BFD	23 1/2"	29 1/2"	3/4"

- Matches ordered door style
- 3/4" thick, decorative panel for finishing sides of exposed cabinetry
- Flat back; requires a BSK to sit flush on cabinet side

BFD

MOLDING & TRIM CODES

FMT **ACM8**

Door Style Code Molding & Trim Code

Letters represent type of cabinet

ACM **8**

Angled Crown Molding Length

DETAILS

- Use BM8, OC8, SCM8 to finish seams, end of runs, and corners where panels meet

MOLDINGS & TRIM CONSTRUCTION KEY

- Solid Wood
- Veneered MDF
- Veneered Plywood

Angled Crown Molding **ACM8**

- Solid wood
- Available in a single 8' piece

Crown Molding **CM8**

- Solid wood
- Available in a single 8' piece

Cove Crown Molding **COVE CM8**

- Solid wood
- Available in a single 8' piece

Bull Nose Light Rail **BLR8**

- Solid wood
- Available in a single 8' piece

Scribe Molding **SCM8**

- Solid wood
- Available in a single 8' piece

Shoe Molding **SHM8**

- Solid wood
- Available in a single 8' piece

Outside Corner Molding **OC8**

- Solid wood
- Available in a single 8' piece

Traditional Light Rail **TLR8**

- Solid wood
- Available in a single 8' piece
- * While supplies last

Arched Valance **VAA37**
VAA49

- 3/4" thick solid wood
- Can be cut down on either side

Toe Kick **TK8**

- 1/2" thick veneered plywood
- Available in a single 8' piece

Round Bun Foot **BFT-R**

- Solid wood
- 3 1/2" wide
- 4 1/2" high

Square Bun Foot **BFT-S**

- Solid wood
- 3 1/2" wide
- 4 1/2" high

Universal Scoop Trim

UST8

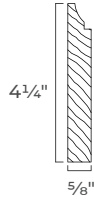
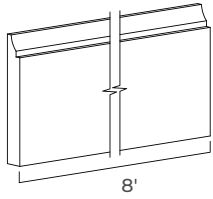

CROWN INSTALL DIAGRAM

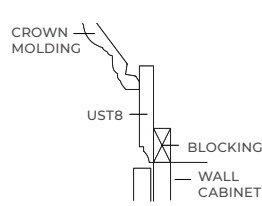

BASE INSTALL DIAGRAM

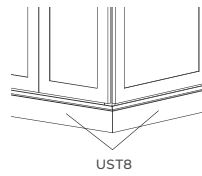

- 5/8" thick solid wood
- Available in a single 8' piece
- Designed for use as decorative baseboard, starter molding for stacking crown to the ceiling, or a valance
- Must order SHM8 when used for base applications

Universal Scoop Base Molding

USBM8

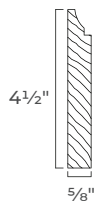
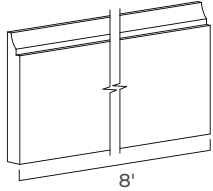

CROWN INSTALL DIAGRAM

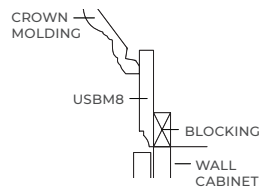

BASE INSTALL DIAGRAM

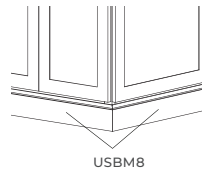

- 5/8" thick solid wood
- Available in a single 8' piece
- Designed for use as decorative baseboard, starter molding for stacking crown to the ceiling, or a valance

Wall Filler

WF342
WF642

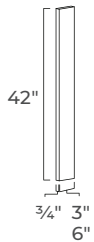

- 3/4" thick solid wood
- Finished front and long sides
- Cut width and height to fit as needed

Base Filler

BF3

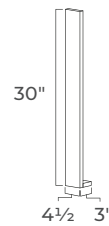

- 3/4" thick solid wood
- Finished front, back, and sides
- Cut width and height to fit as needed

Tall Filler

TF396
TF696

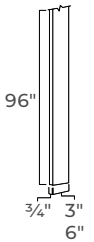

- 3/4" thick solid wood
- Finished front and sides
- Cut width and height to fit as needed

Decorative Leg

DL3.5

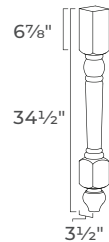

- Solid wood
- Trimmable up to 6" from the top

Split Decorative Leg

DLS3.5

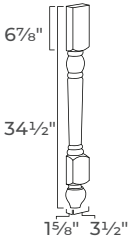

- Solid wood
- Trimmable up to 6" from top
- Can be applied to TF696 or WF642; cut to a min. of 3 1/2" wide
- When installing on a 3 1/2" wide filler, adjust hinges on adjacent doors to prevent binding on leg

Classic Corbel

COR-CLASSIC

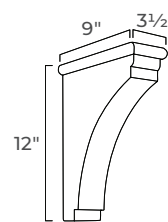

- Solid wood
- Installation bracket included
- Pre-finished to specified color

Shaker Corbel

COR-SHAKER

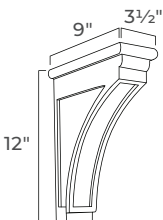



- Solid wood
- Installation bracket included
- Pre-finished to specified color

Choice Essentials

DOOR STYLES

All Choice Essentials® have: partial overlay, slab drawer front, mortise and tenon, and MDF stile and rail.

DOOR CONSTRUCTION KEY

-  Solid Wood
-  Veneered MDF

SUMMIT (SUM)

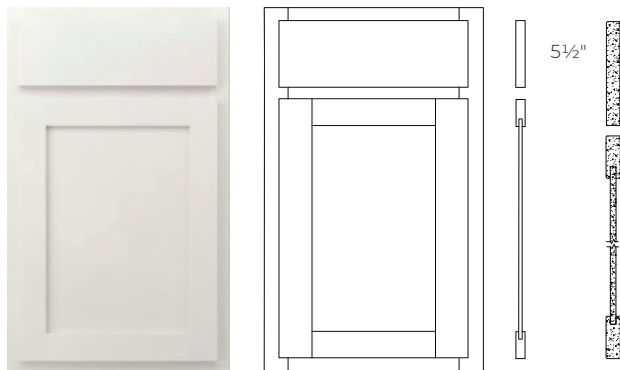

- White painted finish
- MDF center panel

SLATE (SLA)



- Gray stained finish
- Veneered MDF center panel

ASH (ASH)

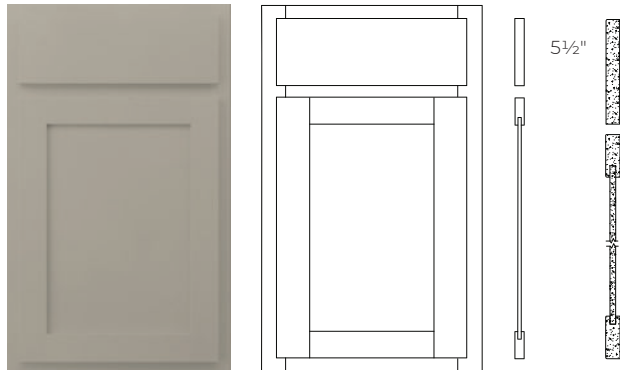

- Gray painted finish
- MDF center panel

LATTE (LAT)

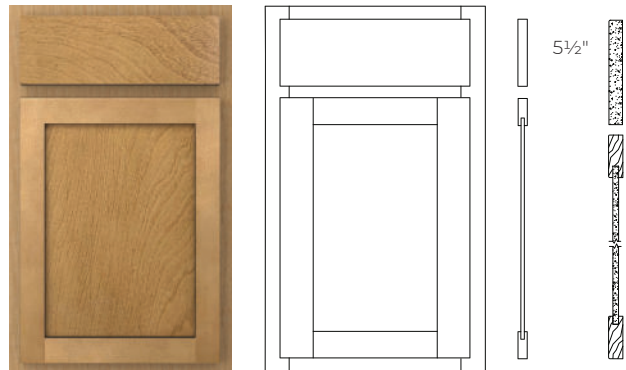

- Natural stained finish
- Veneered MDF center panel

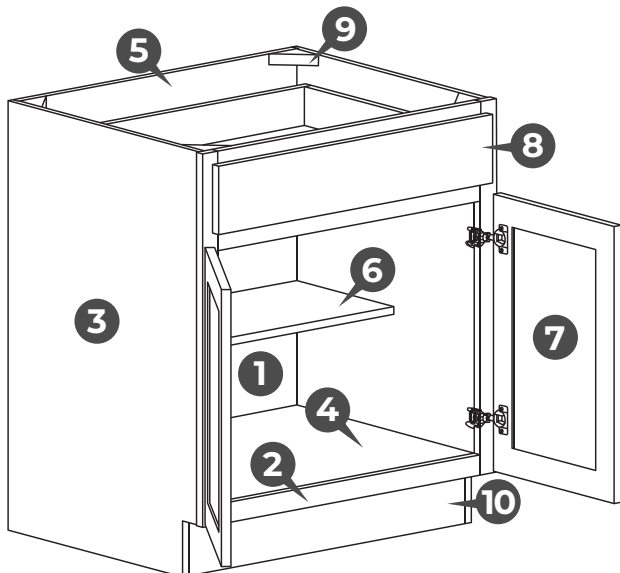
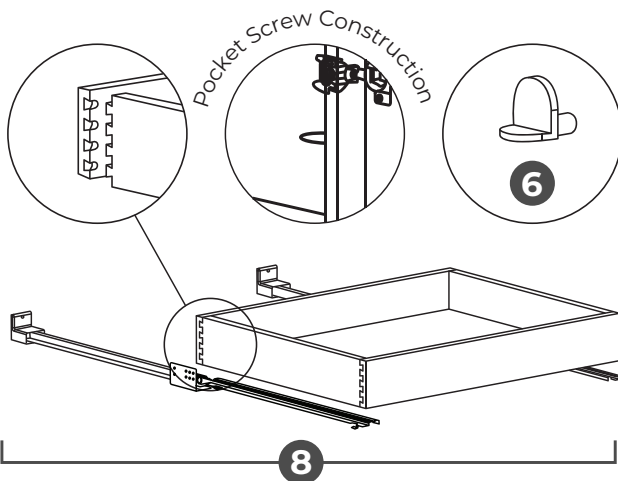
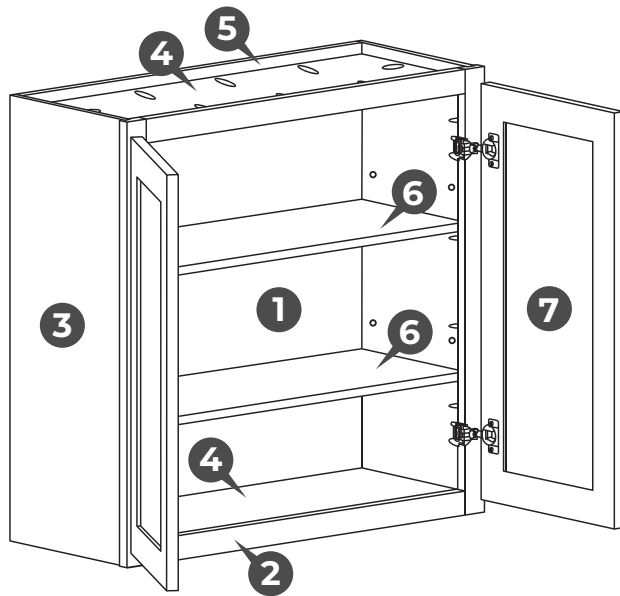

CONSTRUCTION

- 1** Natural hardwood interior
- 2** 3/4" solid hardwood face frame
- 3** 1/2" veneered plywood end panels with matching exterior finish
- 4** 1/2" veneered plywood captured floor and ceiling panels with natural finish
- 5** 5/8" framed plywood back
- 6** 3/4" veneered plywood half depth, adjustable shelving with metal shelf clips
- 7** Partial overlay stile and rail with veneered or painted MDF center panel and 6-way adjustable, concealed soft-close hinges
- 8** Partial overlay veneered or painted MDF slab drawer bottom, and 7/8 extension under-mount soft-close drawer glides
- 9** 3/4" solid wood corner braces
- 10** 4 1/2" high and 1/2" thick unfinished veneered plywood toe kick

1-YEAR LIMITED WARRANTY

EPA COMPLIANCE



WALL CABINET CODES

FMT W3012

Door Style Code Cabinet Code

Letter represents type of cabinet

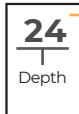
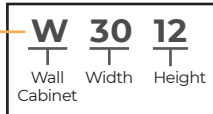

If the depth is different from the Wall Cabinet standard of 12", it is represented by a third set of numbers.

DETAILS

- Wall cabinetry is 12" deep unless otherwise noted

Wall Bridge Double Door 12" High

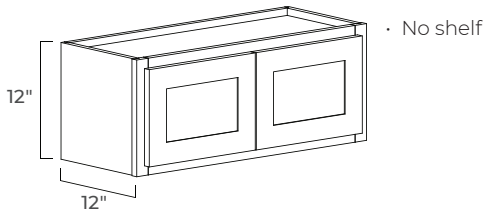

- W3012
- W3312
- W3612

Wall Bridge Double Door 15" High

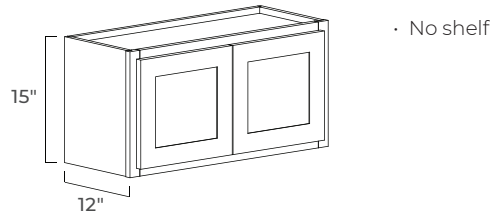

- W2415
- W3015
- W3315
- W3615

Wall Bridge Double Door 18" High

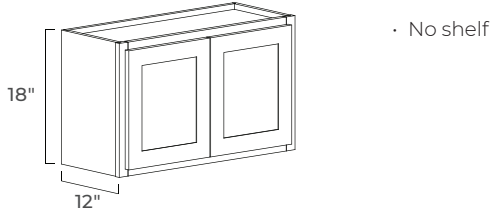

- W2418
- W3018
- W3318
- W3618

Wall Bridge Double Door 24" High

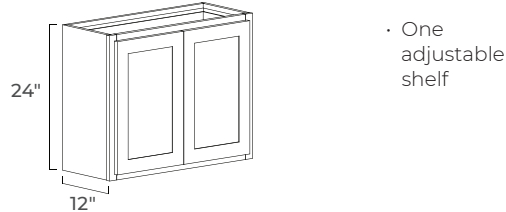

- W2424
- W3024
- W3324
- W3624

Wall Bridge Refrigerator Double Door 24" Deep

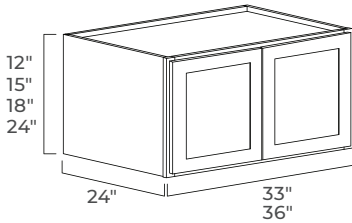

- No shelf
- For installation between a combination of cabinets, refrigerator panels, or two walls for support
- * One adjustable shelf

- W331224
- W331824
- W332424*
- W361224
- W361524
- W361824
- W362424*

Wall Microwave

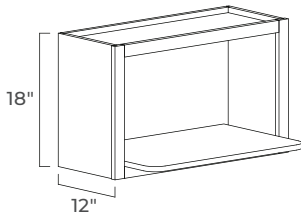

INTERIOR DIMENSIONS

SKU	WIDTH	HEIGHT	DEPTH
MC3018	28 3/4"	14 1/4"	10 5/8"

FRAME OPENING WITH SHELF DIMENSIONS

SKU	WIDTH	HEIGHT	DEPTH
MC3018	26 3/4"	14"	17 1/2"

- Finished interior
- For countertop-style microwave
- One finished shelf: 5/8" thick, 18" deep
- For installation between two cabinets or a cabinet and a wall

- MC3018

Wine Rack

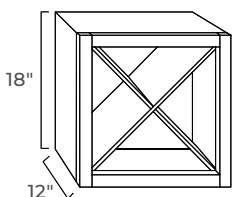

- Finished interior
- Holds sixteen standard sized 750ml wine bottles
- Stackable

- WR1818

Wall Filler

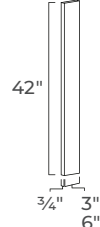

- 3/4" thick solid wood
- Finished front and long sides
- Cut width and height to fit as needed

- WF342
- WF642

Wall Single Door 30" High

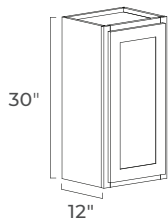

- Two adjustable shelves

W0930
W1230
W1530
W1830
W2130

Wall Single Door 36" High

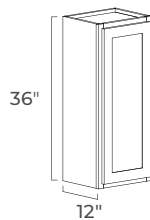

- Two adjustable shelves

W0936
W1236
W1536
W1836
W2136

Wall Single Door 42" High

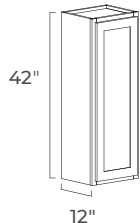

- Three adjustable shelves

W0942
W1242
W1542
W1842
W2142

Wall Double Door 30" High

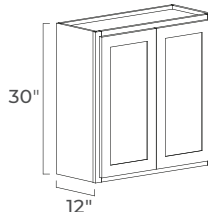

- Two adjustable shelves

W2430
W2730
W3030
W3330
W3630

Wall Double Door 36" High

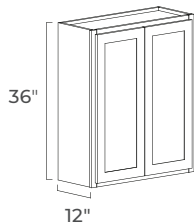

- Two adjustable shelves

W2436
W2736
W3036
W3336
W3636

Wall Double Door 42" High

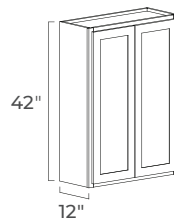

- Three adjustable shelves

W2442
W2742
W3042
W3342
W3642

Wall Diagonal Corner

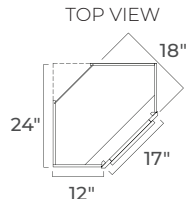
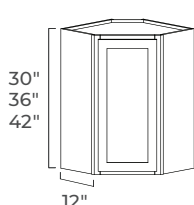

WDC2430
WDC2436
WDC2442*

- 24" wide
- Two adjustable shelves
- * Three adjustable shelves

Wall Diagonal Corner

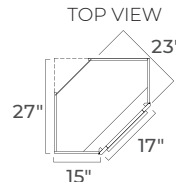
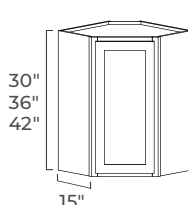

WDC2730
WDC2736
WDC2742

- 27" wide
- Two adjustable shelves

Wall Single Door Blind Corner

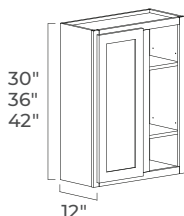

FACE FRAME OPENING DIMENSIONS

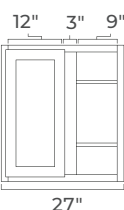

INSTALLATION DIAGRAM

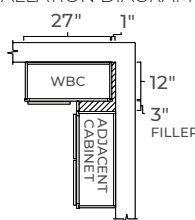

- Two adjustable shelves
- 27" wide
- Requires 1" pull from adjacent wall (28" total installed width)
- Flip for left or right application
- 3" wall filler included
- Same door and opening sizes as W1530, W1536, and W1542
- * Three adjustable shelves

WBC2830
WBC2836
WBC2842*

Wall Single Door Blind Corner

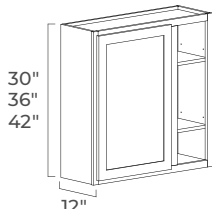

FACE FRAME OPENING DIMENSIONS

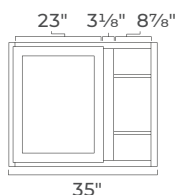

INSTALLATION DIAGRAM

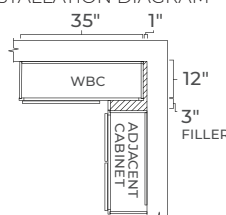

- Two adjustable shelves
- 35" wide
- Requires 1" pull from adjacent wall (36" total installed width)
- 3" filler included
- Same doors and opening sizes as W2430
- Hinged on center stile of face frame; can be flipped for left or right application during assembly
- * Three adjustable shelves

WBC3630
WBC3636
WBC3642*

BASE CABINET CODES

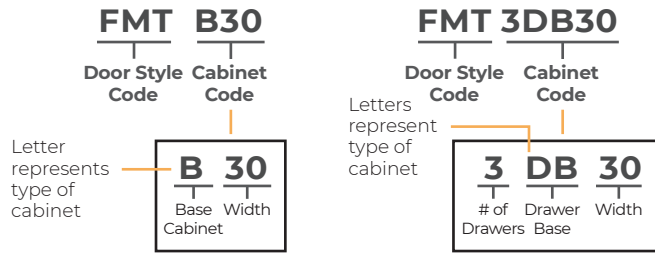

DETAILS

- Base cabinetry is 24" deep unless otherwise noted
- Single door base cabinetry is hinged on the right side of the face frame and can be flipped in the field as necessary

Base Single Door

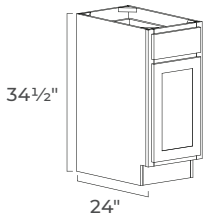

- One adjustable half shelf

- B09
- B12
- B15
- B18
- B21

Base Full Height

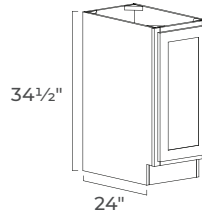

- One adjustable half shelf

BFH09

Base Double Door

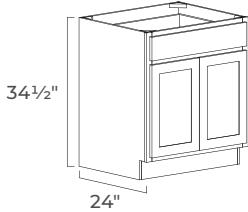

- One adjustable half shelf

- B24
- B27
- B30
- B33
- B36

Two Drawer Base

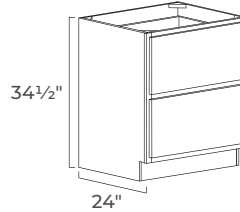

- Two deep drawers

2DB30
2DB36

Three Drawer Base

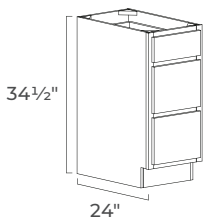

- One standard depth drawer
- Two deep drawers
- Top drawer aligns with standard base cabinetry

- 3DB12
- 3DB15
- 3DB18
- 3DB21
- 3DB24
- 3DB30
- 3DB36

Sink Base

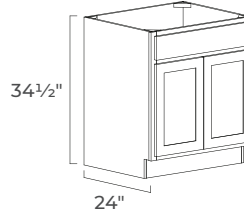

- False drawer front

SB30
SB33
SB36

Farmhouse Sink Base

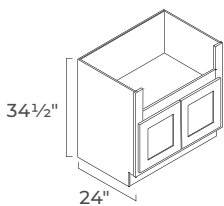

- 36" wide; fits most 30–33" wide farmhouse sinks
- Face frame may be trimmed in field per sink specifications
- Opening: 30" W x 8" H (width and height can be increased independently up to 33" W x 11" H)
- Uses same size doors as W3618

FSB36

Microwave Base

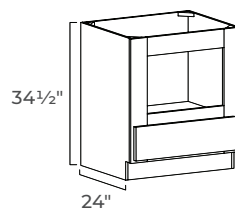

- 28" wide
- 10 1/4" high drawer
- Finished interior
- Opening*: 21" W x 14 1/2" H (width and height can be increased independently up to 27" W x 18" H)
- * 4 1/2" pocket frame stiles can be modified as needed

MWB30

Angled Full Height Base

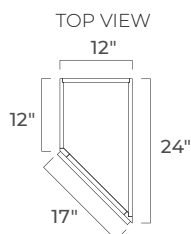
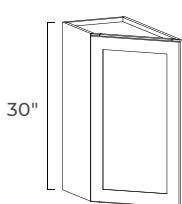

- One adjustable shelf
- Full-height door
- Hinged on center stile of face frame; can be flipped for left or right application during assembly by inverting cabinet
- Toe kick not included
- Installer must build toe kick support and conceal with TK8

AFHB12

Lazy Susan

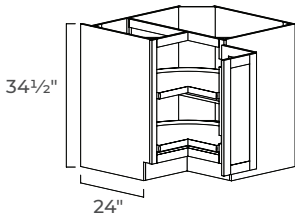

FACE FRAME OPENING DIMENSIONS

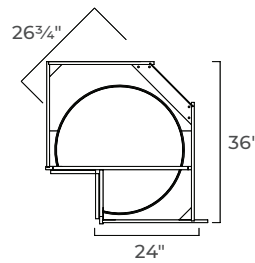

- Full height, bi-folding doors
- Two rotating pie-cut trays
- Trays: veneered plywood with a solid wood perimeter lip
- Under-mount bearings allow for independent rotation and full access to trays
- Soft-close not available
- Right hinged
- Magnetic door catch attached

LS33-R
LS33-L
LS36-R
LS36-L

Lazy Susan Diagonal Door

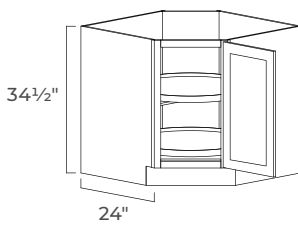

FACE FRAME OPENING DIMENSIONS

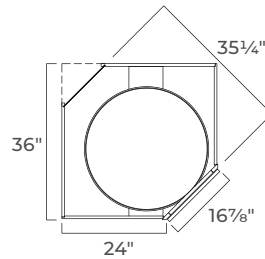

- Full height door
- Two rotating full-circle trays
- Trays: veneered plywood with solid wood perimeter lip
- Under-mount rotating bearing allows for independent rotation and full access to trays

LS36DD

Base Blind Corner

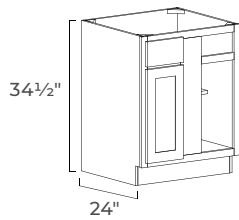

FACE FRAME OPENING

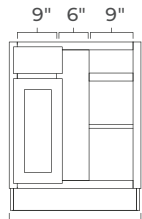

27" WITH 9 1/16" DOOR

INSTALLATION DIAGRAM

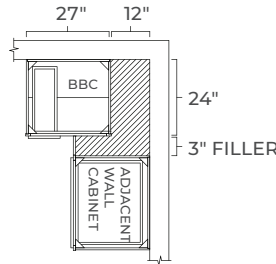

- One adjustable half shelf
- 27" wide; must be pulled minimum 12" from adjacent wall
- Hinged on center stile of face frame; door and drawer can be flipped for left or right application during assembly
- 3" filler included
- Same size door, drawer, and door opening as B12

BBC39

Base Blind Full Height

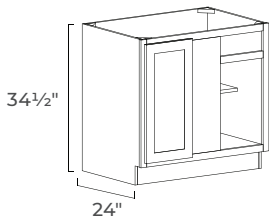

FACE FRAME OPENING

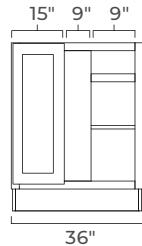

36"

INSTALLATION DIAGRAM

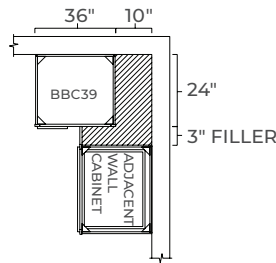

- Full height door
- One adjustable half shelf
- 36" wide; must be pulled minimum 10" from adjacent wall
- Hinged on center stile of face frame; front can be flipped for left or right application during assembly
- 3" filler included
- Same door opening as B18

BBFH46-49

Base Filler

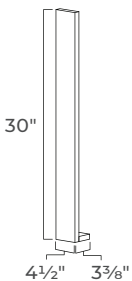

- 3/4" thick solid wood
- Finished front, back, and sides
- Cut width and height to fit as needed

BF3

TALL CABINET CODES

FMT UP1884

Door Style Code Cabinet Code

UP 18 84

Letters represent type of cabinet

UP
18
84

Tall Cabinet
Width
Height

DETAILS

- Tall cabinetry is 24" deep unless otherwise noted

Oven Cabinet

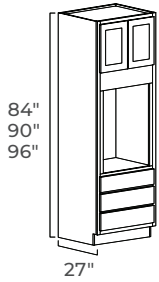

FRAME OPENING (MIN) DIMENSIONS

SKU	WIDTH	HEIGHT	DEPTH
OV3384	27"	29¼"	22⅝"
OV3390	27"	29¼"	27"
OV3396	27"	29¼"	22⅝"

- No shelf in top section
- Three drawers in lower section
- Removable drawers and trimmable frame allow for larger appliances
- Drawer size – Top: 31" x 5½"; Bottom/Middle: 31" x 10¼"

- OV3384
- OV3390
- OV3396

FRAME OPENING (MAX) DIMENSIONS

SKU	WIDTH	HEIGHT	DEPTH
OV3384	31¼"	66"	23⅜"
OV3390	31¼"	66"	23⅜"
OV3396	31¼"	66"	23⅜"

ADDITIONAL INFORMATION

SKU	UPPER DOOR HEIGHT	DOOR SIZE
OV3384	8"	10" x 15⅜"
OV3390	14"	16" x 15⅜"
OV3396	20"	22" x 15⅜"

Utility Pantry Single Door

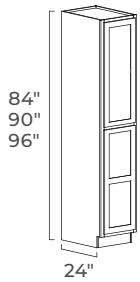

ADDITIONAL INFORMATION

SKU	UPPER DOOR HEIGHT	# OF UPPER SHELVES	# OF LOWER SHELVES
UP1884	28"	ONE	TWO
UP1890	34"	ONE	TWO
UP1896	40"	TWO	TWO

- Lower door has center rail, creating a two-door panel door design
- Accepts 18" rollout trays (ACC ROT18 ordered separately)
- Magnetic door catch attached
- Universal bottom door height: 47¾"
- Pantry door width: 16"

- UP1884
- UP1890
- UP1896

Utility Pantry Double Door

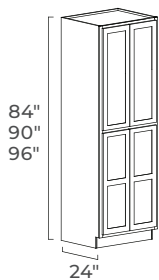

ADDITIONAL INFORMATION

SKU	UPPER DOOR HEIGHT	# OF UPPER SHELVES	# OF LOWER SHELVES
UP2484	28"	ONE	TWO
UP2490	34"	ONE	TWO
UP2496	40"	TWO	TWO

- Lower door has center rail, creating a two-door panel door design
- Accepts 24" rollout trays (ACC ROT24 ordered separately)
- Magnetic door catch attached
- Universal bottom door height: 47¾"
- Pantry doors width: 11"

- UP2484
- UP2490
- UP2496

Tall Filler

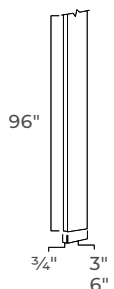

- ¾" thick solid wood
- Finished front and sides
- Cut width and height to fit as needed

- TF396
- TF696

BATHROOM VANITY CODES

FMT VSB243421

Door Style Code

Cabinet Code

If the cabinet has drawers it's represented by a number in front of the style

3

of Drawers

Letters represent type of cabinet

VSB

Vanity Sink Base

24

Width

34

Height

21

Depth

DETAILS

- Bathroom vanities are 34½" high and 21" deep unless otherwise noted

Vanity Sink Base

34½"

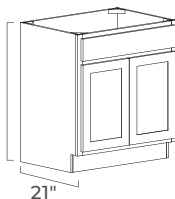

21"

- No shelf
- For single bowl installation only
- Two doors
- Top drawer is a false drawer front
- Finished toe kick included (made to width)

VSB243421

VSB303421

VSB363421

Vanity Combo: Two Drawer/One Door

34½"

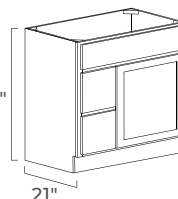

21"

- No shelf
- For single bowl installation only
- Drawers always 12" wide
- Top drawer is a false drawer front
- Finished toe kick included (made to width)
- * V303421L shown

V303421L*

V303421R

Vanity Combo: Two Drawer/Two Door

34½"

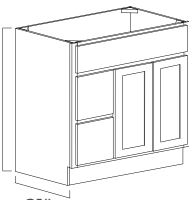

21"

- No shelf
- For single bowl installation only
- Drawers remain 12" wide
- Top drawer is a false drawer front
- Finished toe kick included (made to width)
- * V36341L shown

V363421L*

V363421R

Vanity Combo: Two Drawer/Three Door

34½"

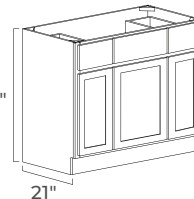

21"

- No shelf
- For single bowl installation only
- Drawers remain 12" wide
- Top middle drawer is a false drawer front
- Finished toe kick included (made to width)

V423421

Vanity Combo: Six Drawer/Two Door

34½"

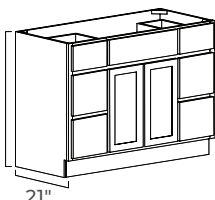

21"

- No shelf
- For single bowl installation only
- Drawers remain 12" wide
- Top middle drawer is a false drawer front
- Finished toe kick included (made to width)

V483421

Three Drawer Vanity Drawer Base

34½"



21"

- One standard depth drawer
- Two deep drawers
- Top drawer aligns with standard base cabinetry
- Finished toe kick included (made to width)

3VDB123421

3VDB153421

3VDB183421

Vanity Combo: Three Drawer/Four Door

34½"

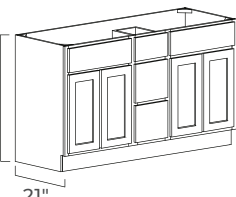

21"

- No shelf
- For double bowl installation only
- Drawers remain 12" wide
- Two outside top drawers are false drawer fronts
- Finished toe kick included (made to width)

V603421D

Vanity Combo: Six Drawer/Two Door

34½"

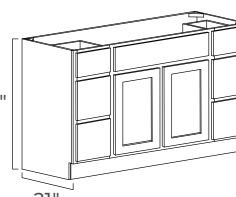

21"

- No shelf
- For single bowl installation only
- Drawers remain 12" wide
- Top middle drawer is a false drawer front
- Finished toe kick included (made to width)

V603421S

Bathroom Vanity Filler

42"

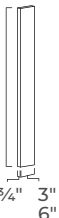

¾" 3" 6"

- ¾" thick, solid wood
- Finished front and sides
- Cut width and height to fit as needed

WF342

WF642

PANEL & SKIN CODES

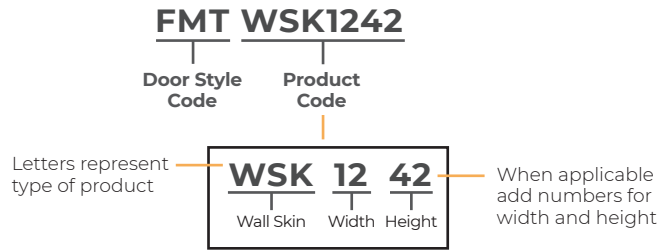

Base Skin

BSK

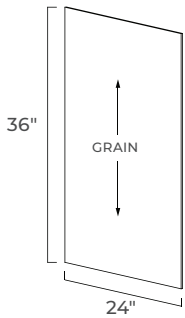

- ¼" thick; one finished side
- For skinning sides of base cabinetry
- Cut width and height to fit; notch for toe kick as needed
- Install flush with cabinet frame
- Stained: veneered plywood or MDF core construction
- Painted: MDF core construction

Wall Skin

WSK1242

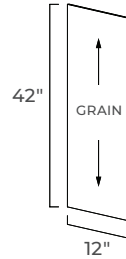

- ¼" thick; one finished side
- For skinning sides of wall cabinetry
- Cut width and height to fit
- Install flush with cabinet frame
- Stained: veneered plywood or MDF core construction
- Painted: MDF core construction

Back Skin

BS9636

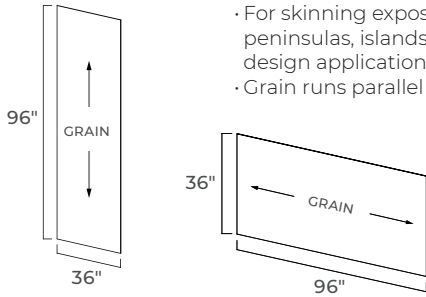

- ¼" thick; one finished side
- For skinning exposed backs of peninsulas, islands, and other design applications
- Grain runs parallel with 96" sides

Tall Skin

TSK2496

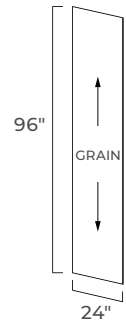

- ¼" thick; one finished side
- For skinning sides of tall cabinetry
- Cut width and height to fit
- Notch for toe kick in field as necessary
- Install flush with frame
- Stained: veneered plywood or MDF core construction
- Painted: MDF core construction

Dishwasher Panel

DWP

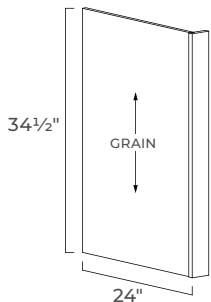

- Install next to a dishwasher
- ¾" thick, veneered plywood panel, finished on outside
- Panel bored for assembly along one unfinished side
- 3" wide, ¾" thick, solid wood return filler, finished on front and sides

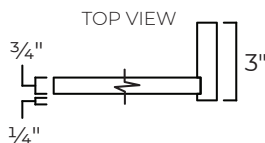

Refrigerator Panel

RP2496

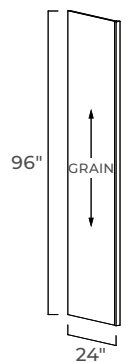

- Install next to or flanking a refrigerator to conceal sides and support wall cabinetry above appliance
- ¾" thick, veneered plywood panel, finished on both sides
- Panel bored for assembly along one side
- 1½" wide, ¾" thick, solid wood return filler, finished on front and sides

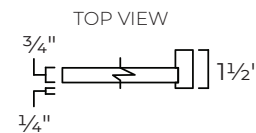

MOLDING & TRIM CODES		DETAILS				
FMT Door Style Code	ACM8 Molding & Trim Code	• Use BM8, OC8, SCM8 to finish seams, end of runs, and corners where panels meet				
Letters represent type of cabinet	<table style="width: 100%; text-align: center;"> <tr> <td style="border: 1px solid black; padding: 2px;">ACM</td> <td style="border: 1px solid black; padding: 2px;">8</td> </tr> <tr> <td style="font-size: 8px;">Angled Crown Molding</td> <td style="font-size: 8px;">Length</td> </tr> </table>		ACM	8	Angled Crown Molding	Length
ACM	8					
Angled Crown Molding	Length					
MOLDINGS & TRIM CONSTRUCTION KEY						
<table style="width: 100%;"> <tr> <td style="width: 33%;"> Solid Wood</td> <td style="width: 33%;"> Veneered MDF</td> <td style="width: 33%;"> Veneered Plywood</td> </tr> </table>		Solid Wood	Veneered MDF	Veneered Plywood		
Solid Wood	Veneered MDF	Veneered Plywood				

Angled Crown Molding ACM8

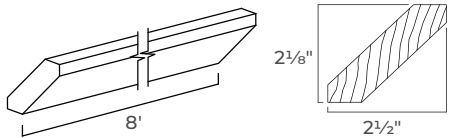

- Solid wood
- Available in a single 8' piece

Batten Molding BM8

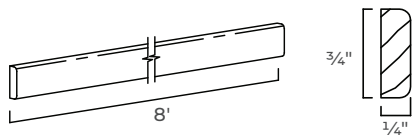

- Solid wood
- Available in a single 8' piece

Cove Crown Molding COVE CM8

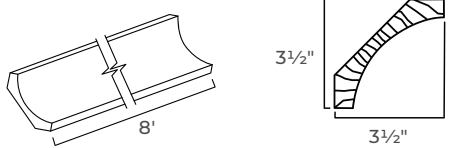

- Solid wood
- Available in a single 8' piece

Scribe Molding SCM8

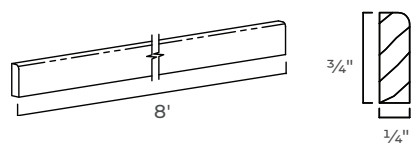

- Solid wood
- Available in a single 8' piece

Shoe Molding SHM8

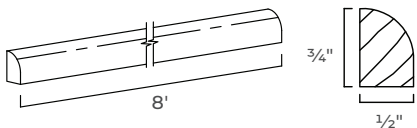

- Solid wood
- Available in a single 8' piece

Outside Corner Molding OC8

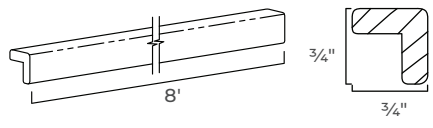

- Solid wood
- Available in a single 8' piece

Traditional Light Rail TLR8

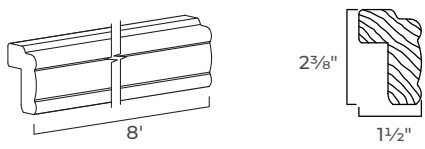

- Solid wood
- Available in a single 8' piece
- * While supplies last

Toe Kick TK8

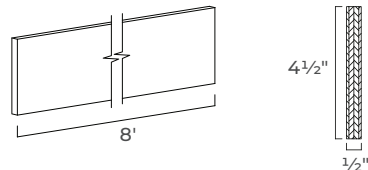

- 1/2" thick veneered plywood
- Available in a single 8' piece

Universal Scoop Base Molding

USBM8

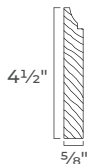
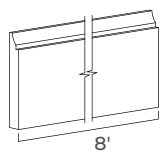

CROWN INSTALL DIAGRAM

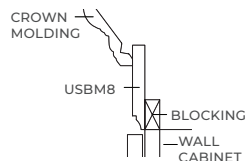

BASE INSTALL DIAGRAM

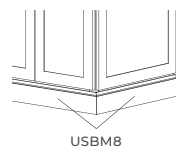

- 5/8" thick solid wood
- Available in a single 8' piece
- Designed for use as a decorative baseboard, starter molding for stacking crown to the ceiling, or a valance

Wall Filler

WF342
WF642

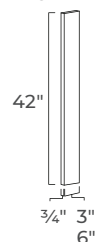

- 3/4" thick solid wood
- Finished front and long sides
- Cut width and height to fit as needed

Base Filler

BF3

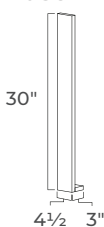

- 3/4" thick solid wood
- Finished front, back, and sides
- Cut width and height to fit as needed

Tall Filler

TF396
TF696

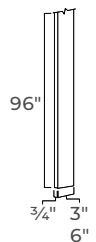

- 3/4" thick solid wood
- Finished front and sides
- Cut width and height to fit as needed

Accessories & Resources

DECORATIVE HARDWARE CODES

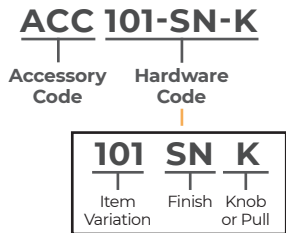

DETAILS

- Hardware items can be used with both Choice Select® and Choice Essentials® lines
- Can be viewed on our website
- Available in Satin Nickel, Rose Gold, and Matte Black finish

Bar Pull Knob



101-SN-K
101-RG-K
101-BK-K

- 2" length

Round Flat Top Knob



102-SN-K
102-RG-K
102-BK-K

- 1¼" diameter

Square Knob



103-SN-K
103-RG-K
103-BK-K

- 1¼" width

Spherical Knob



104-SN-K
104-RG-K
104-BK-K

- 1⅝" diameter

Diecast Knob



105-SN-K
105-RG-K
105-BK-K

- 1¼" diameter

6" Bar Pull



201-SN-P
201-RG-P
201-BK-P

- 6" overall length
- 3¾" center to center

10" Bar Pull



202-SN-P
202-RG-P
202-BK-P

- 10" overall length
- 7" center to center

4" Deco Pull



203-SN-P
203-RG-P
203-BK-P

- 4¼" overall length
- 3¾" center to center

Cup Pull



204-SN-P
204-RG-P
204-BK-P

- 3¾" overall length
- 3" center to center

6" Deco Pull



205-SN-P
205-RG-P
205-BK-P

- 5½" overall length
- 5" center to center

7" Square Edge Pull



206-SN-P
206-RG-P
206-BK-P

- 7½" overall length
- 6¼" center to center

4" Square Edge Pull



207-SN-P
207-RG-P
207-BK-P

- 4¾" overall length
- 3¾" center to center

4" Colorado Pull



208-SN-P
208-RG-P
208-BK-P

- 4½" overall length
- 3¾" center to center

7" Colorado Pull



209-SN-P
209-RG-P
209-BK-P

- 7" overall length
- 6¼" center to center

Satin Nickel (SN)



Rose Gold (RG)



Matte Black (BK)



TOUCH UP CODES

ACC	FMT	MARKER
Accessory Code	Door Style Code	Product Code

DETAILS

<p>Paint Aerosols</p> <ul style="list-style-type: none"> Lower solids, opaque, pre-cat lacquer For touch-ups or onsite topcoats Apply at least 3 coats on raw wood <p>Paint Quarts</p> <ul style="list-style-type: none"> Higher solids, opaque, pre-cat lacquer For shop spraying (trim, crown, re-finish doors, etc.) No clear topcoat required 	<p>Stain Quarts</p> <ul style="list-style-type: none"> Production wipe stain Apply like standard wipe stain Dry 20–30 minutes before toner or topcoat Clear topcoat required for protection <p>Clear Aerosols</p> <ul style="list-style-type: none"> Lower solids, clear, pre-cat lacquer Use over all stained or glazed surfaces
---	---

Touch-Up Marker MARKER

- Felt-tipped marker filled with stain or paint
- For small scuffs or scratches

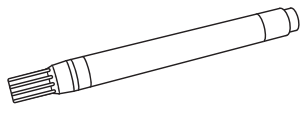

Wax Fill Stick FILL STICK

- For small punctures and deep scratches

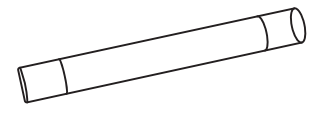

Quart of Paint PAINT

- 1 quart of paint



Quart of Stain STAIN

- 1 quart of stain
- Stained door styles require a clear topcoat (order ACC CLEAR-AEROSOL separately)



Can of Aerosol Paint PAINT AEROSOL

- Pre-catalyzed

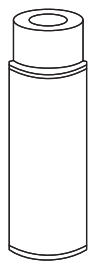

Can of Aerosol Topcoat CLEAR AEROSOL

- Pre-catalyzed



STORAGE ACCESSORY CODES

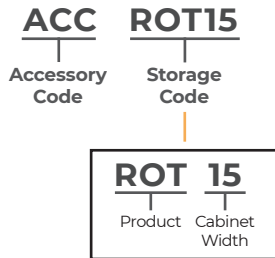

DETAILS

- Storage & Accessory items can be used with Choice Select® and Choice Essentials® lines

Roll-Out Tray

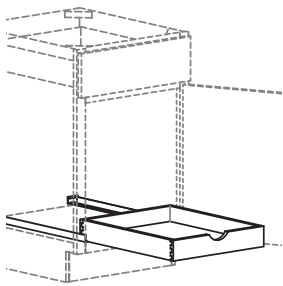

- Sold individually and separately from cabinet
- Solid wood dovetailed construction
- 2½" high sides
- Under-mount, full extension soft-close glides
- For 24" deep cabinets

ROT15
ROT18
ROT21
ROT24
ROT27
ROT30
ROT33
ROT36

Trash Pull-Out Single Bin

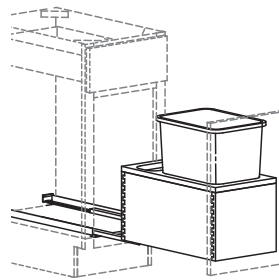

- Sold separately from cabinet
- Solid wood dovetailed base support construction
- Under-mount, full extension soft-close glides
- Includes one 35 qt. white waste container

TPOS15

Trash Pull-out Double Bin

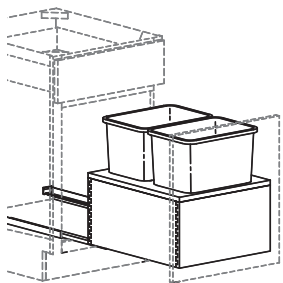

- Sold separately from cabinet
- Solid wood dovetailed base support construction
- Under-mount, full extension soft-close glides
- Includes two 35 qt white waste containers

TPOD18
TPOD21

Wood Tray Divider

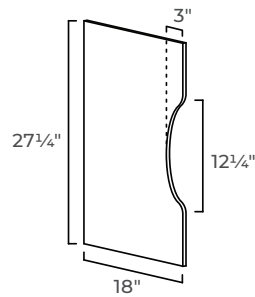

- Sold Individually
- ¾" thick veneered plywood with edge-banded front
- Natural hardwood finish
- Cut width and height as needed

TRAY DIV

Wood Cutlery Divider

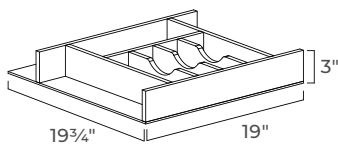

- Solid wood with natural hardwood finish
- Features ½" thick solid wood dividers throughout
- Choice Select®: Designed to fit top drawer of 24" wide base cabinet; can be cut to fit 18" or 21" wide cabinets
- Choice Essentials®: Requires trimming to fit 18"-24" wide base cabinets

WCD

GLIDES & HINGES CODES			DETAILS			
ACC	GLIDE	UMSC15	ACC	6ADJSCH-FO	<ul style="list-style-type: none"> Not all glides and hinges are interchangeable between the Choice Select® and Choice Essentials® lines 	
Accessory Code	Glide Code	Glide Item	Accessory Code	Hinge Item		
UM	SC	15	6ADJ	SCH		FO
Under-Mount	Soft-Close	Cabinet Depth	6 Way Adjustable	Soft-Close Hinge		Full Overlay

Under-Mount Soft-Close Glide Pair

- Sold as a pair
- Receivers included
- Under-mount, full extension, soft-close
- Size designation corresponds to cabinet depth, not glide length
- Item code must be preceded by "ACC GLIDE"

UMSC15
UMSC18
UMSC21
UMSC24

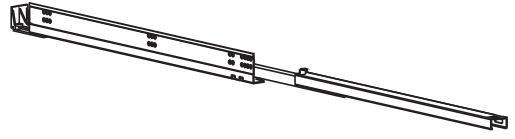

Under-Mount Partial Extension Glide Pair

- Sold as a pair
- Receivers included
- Under-mount, ¾ extension, soft-close
- Size designation corresponds to cabinet depth, not glide length
- Item code must be preceded by "ACC GLIDE"

UMSC21-PE
UMSC24-PE

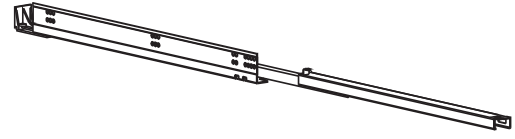

6-Way Adjustable Soft-Close Hinge Full Overlay

- 6-way adjustable
- Integrated soft-close with on/off toggle switch

6ADJSCH-FO



6-Way Adjustable Soft-Close Hinge Partial (Standard) Overlay

- 6-way adjustable
- Integrated soft-close with on/off toggle switch

6ADJSCH-PO



Hinge Spacer

- For adjusting cup holes on larger doors

SPACER

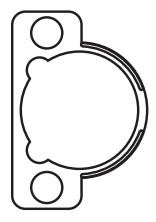

SAMPLE CODES



DETAILS

- Samples are available in Choice Select® and Choice Essentials® lines

Sample Door

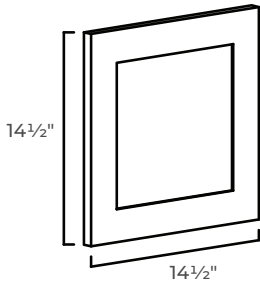

SAMPLE DOOR SAMPLE DOOR PACK*

- Order doors separately or together as a pack
- Pack includes all door styles
- * Door style order code not required

Sample Base Front

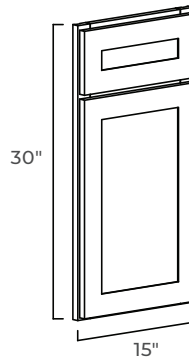

SAMPLE BASE FRONT SAMPLE BASE FRONT PACK*

- Order base fronts separately or together as a pack
- Pack includes all door styles
- * Door style order code not required

Sample Trim Kit

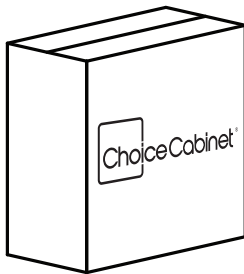

SAMPLE TRIM KIT*

- * Door style order code not required

Selection Center

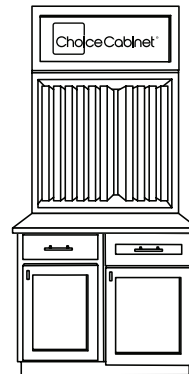

SELECTION CENTER

- 36" width
- Includes:
 - (2) 18" base cabinets (Essentials and Select)
 - Continuous countertop
 - Swinging sample fronts
 - Wall cabinet (W3018), mounted above
- Features:
 - Hands-on selection experience
 - Compact unit showcasing a range of finishes, edge profiles, and hardware options
- * Door style order code not required

DETAILS

- Made To Order (MTO) items include Range Hoods, Mullion Inserts and Floating Shelves
- Specification details for MTO items are provided in separate guides available in the Resources tab on our website or through your sales representative.
- Ordering is available through your sales representative.



Mullions



Range Hoods



Floating Shelves

SAMPLE CODES

MKT QUICK LOOK GUIDE

Marketing Code

Literature Code

DETAILS

- Literature items are available in both professionally printed and digital formats
- Please refer to the guides for more options and information about our mullions, hoods, and floating shelves

Quick Look Guide

QUICK LOOK GUIDE

- Pre-packed in quantities of 100pcs
- 8.5"x11" tri-fold brochure



Spec Sheet

SPEC SHEET

- Pre-packed in quantities of 100pcs
- 8.5" x 11" double-sided flyer

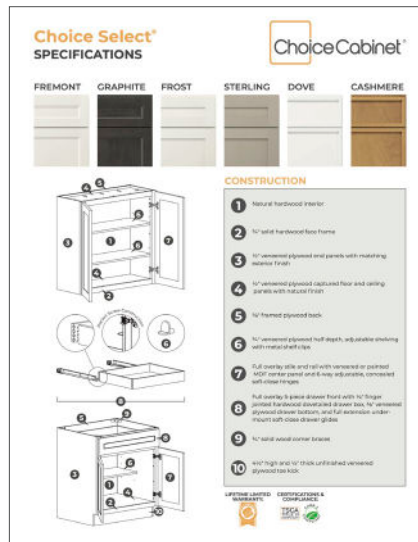

Bathroom Vanity Guide

BATHROOM VANITY GUIDE

- Pre-packed in quantities of 25pcs
- 11"x17" bi-fold brochure



Cabinetry Guide

CABINETRY GUIDE

- Sold individually
- 8.5"x11" catalog



Care & Coverage

HOW TO CLEAN

Choice cabinetry has a finish that's similar to what you'd find on a well-made piece of furniture. It's built to handle the wear and tear of everyday life, but keeping it clean and well-maintained still makes a big difference. With a little regular care, your cabinets can stay looking great and hold up for many years to come.

DUSTING

Keep your cabinets looking their best by dusting them regularly with a soft, lint-free cloth. If needed, you can lightly dampen the cloth with water or use a spray dust cleaner.

SPILLS

Be sure to wipe up spills right away. Letting food, water, grease, or other liquids sit too long can stain or damage the finish. For cleanup, use a soft cloth with a little mild soap, then dry the area right away with another clean, soft cloth.

CLEANING

For general cleaning, the same method works well, just a gentle soap and a soft cloth, followed by drying. You can also use wood cleaners made specifically for cabinetry if you prefer.

WAXING & POLISHING

Skip the wax. It's not necessary and can actually cause problems over time. Wax buildup can leave cabinets looking cloudy, streaky, or yellow, and it tends to attract dust. Instead, plan to clean and polish your cabinets once or twice a year using a light coat of a good-quality furniture polish.

GLASS DOORS

If your cabinet doors have glass panels, it's a good idea to clean them every now and then. You can use a regular glass cleaner—just don't spray it straight onto the glass. Instead, spray a little onto a soft cloth or paper towel and wipe it down. That way, you avoid getting cleaner on the cabinet finish or hardware.

HARDWARE

Knobs, pulls, and handles need some attention too. A soft cloth with a bit of mild soap does the trick. Once you're done, dry everything well, especially around the joints, seams and edges to prevent moisture from causing any damage.

PRODUCTS TO AVOID

- Harsh chemicals
- Solvent or petroleum-based products (like mineral spirits, nail polish remover, and paint thinner)
- Abrasive cleaners
- Anything with ammonia
- Bleach or bleach-based products
- Adhesives that aren't labeled safe for delicate surfaces

CARING FOR CABINETS

SELF-CLEANING APPLIANCES

Appliances with self-cleaning cycles use very high heat. Over time, their seals can wear down, letting heat escape. Because of this, we recommend removing any cabinet doors or drawers next to or above the appliance while the cleaning cycle runs.

HEAT-PRODUCING APPLIANCES

Placing appliances like coffee makers, toaster ovens, or pressure cookers directly under your cabinets is not recommended. The heat and moisture they give off can damage the finish.

UV EFFECTS

Sunlight can change how your cabinets look over time. Depending on the wood, finish, and how the light hits them, you might notice some fading or color changes. That's completely normal.

CABINET MAINTENANCE

Even with the best care, everyday use will eventually show. The good news is there are easy ways to keep your cabinets looking fresh.

TOUCH-UP

There are touch-up markers and fill sticks specially formulated to match our cabinet finishes. If you're not sure how to use them or where to get them, check with your Choice Cabinet Design Professional.

NOTE: For bigger repairs, it's best to call in a professional.

ADJUSTING HARDWARE

Over time, things like door hinges, soft-close pistons, drawer glides, and other hardware may need a quick adjustment. Most of these can be tightened or adjusted using a Phillips-head (cross-head) screwdriver. For soft-close pistons, you can usually adjust them by turning the small dial on the back, often just with your fingers.

PRODUCT & FINISH INFORMATION

Because we use real wood in our products, there are certain characteristics and qualities with which you may not be familiar. Because your satisfaction is our number one priority, we want to make sure you are fully aware of the important information listed below regarding our cabinetry and the applied finish.

EXPANSION & CONTRACTION

Because half of the weight of freshly cut wood is water, these natural properties are such that they can react to climate or humidity changes in your home. Choice Cabinet doors and face frames are manufactured from solid wood that has been carefully kiln-dried, retaining just enough moisture for proper construction and finishing. The center panels of the Choice Cabinet doors are either wood or medium density fiberboard. As a product of nature, solid hardwoods continue to react to their surroundings long after the manufacturing process has been completed. When wood cabinet doors are in a warm, moist environment (high humidity), the wood expands. In a dry, colder environment (low humidity), the wood will contract. Even with humidity regulation, this phenomenon can be controlled, but it can never be completely eliminated.

Door panels are prone to minor expansion and contraction as seasonal temperature and humidity changes occur in a home. The contraction (shrinkage) of the center door panel during low humidity periods may result in the appearance of an unfinished line along the edge of the center panel. Choice Cabinet does not consider the appearance of an unfinished line as a defect and will not replace doors due to this situation. It is recommended that a humidity control system is incorporated in a home to reduce the possibility of expansion and contraction in wood products. Touch-up markers are made available to cover this edge line. Oftentimes, touch-up for this issue may only be necessary within the first year.

Choice Cabinet is not responsible for any of these conditions and variations.

FINISHES

Over time, wood species in all finishes will exhibit color changes when exposed to different types of light and environment. Such color changes are to be expected and are not defects. Due to the natural variation and aging process of wood, minor differences may be observed in color match when replacing doors or adding cabinets at a later date. It is a characteristic of stained and painted wood finishes to age over time when exposed to smoke, sunlight, or general household cleaning chemicals.

Graining differences, mineral streaks, and wood color variations are expected in wood cabinetry and are not classified as defects. A newly installed kitchen could have these minor color variations.

Choice Cabinet offers several types of painted finishes on cabinetry. Painted finishes are exceedingly different from the standard stained finish. Since normal movement is typical in wood products, certain climatic conditions can cause finish breaks, recesses, and joint/panel lines. Joint separation can be more visible on mitered doors. Consequently, in places and environments of extremely high or extremely low humidity, painted finishes are not recommended. Joint lines and variations are common attributes of painted finishes and will not be considered sufficient reasons for product replacement.

Some of our products have glaze finishes. Since glaze detailing is hand applied then hand wiped off, glaze may "hang up" or remain in any corners of the door or drawer profile. Because glaze is a hand applied procedure, detailing can differ from piece to piece.

NOTE: Independent testing has shown that discoloration will develop on doors, drawers, and cabinet parts after continued exposure to tobacco smoke. This is remarkably apparent on white and lighter finishes. We do not warrant discoloration in our products due to exposure to smoke.

JOINT LINES

Expansion and contraction in doors and face frames can cause visible lines at the joints. The finish will still protect the surface, and the structural integrity of the joint will not be affected. An open joint line is not considered a defect.



LIMITED LIFETIME WARRANTY

I. DESCRIPTION OF WARRANTY

This warranty applies only to the original purchaser and is not transferable. From the time of purchase, Choice Cabinet offers a Lifetime Limited Warranty on all of its cabinetry. In addition to cabinetry, all drawers, shelves, roll out trays, and mechanical components are covered under the warranty as well. In the event that any Choice Cabinet product fails during the course of normal use, Choice Cabinet, at its discretion, will either repair or replace the defective product.

Whether the work was performed by a contractor, Choice Cabinet authorized dealer, or you; any expenses involved in the shipping, removal, installation, or consequent damage of the defective product is not covered under this warranty. This warranty does not apply to products installed in mobile homes or recreational vehicles.

II. INTENDED USE OF PRODUCT

To be covered by this warranty, the product must be Use only for its intended purpose(s). Cabinets that have been improperly stored, installed, misused, modified, mishandled, and/or subject to excessive moisture or extreme temperature and humidity levels are not covered under this warranty. In addition, any damage caused by smoking and/or environmental/chemical effects are also not covered under this warranty.

III. ANTICIPATED VARIANCE IN PRODUCT

The Choice Cabinet warranty only applies to product defects and does not apply to properties of natural wood that are inherent in natural wood species. Any time you have a natural wood product, occurrences such as pinholes, knots, and variances in color or grain are normal and are not covered under this warranty.

Because half of the weight of freshly cut wood is water, its natural properties are such that they can react to climate and/or humidity changes in your home. Choice Cabinet doors and face frames are manufactured from solid wood that has been carefully kiln-dried, retaining just enough moisture for proper construction and finishing. These hardwoods continue to react to their surroundings long after the manufacturing process has been completed. When wood cabinet doors are in a warm, moist environment (high humidity), the wood expands. In a dry, colder environment (low humidity), the wood will contract. Even with humidity regulation, this phenomenon can be controlled, but it can never be completely eliminated.

Door panels may also be prone to this minor expansion and contraction as seasonal temperature and humidity changes occur in your home. The contraction (shrinkage) of the center door panel during periods of low humidity may result in the appearance of an unfinished line along the edge of the center panel. Choice Cabinet does not consider the appearance of this line as a defect and will not replace doors due to this situation. Touch-up markers are made available to cover this edge line. The installation of a humidity control system is recommended to reduce the possibility of expansion and contraction in wood products.

All Choice Cabinet doors are manufactured in moisture-controlled environments under precise specifications. Although slight door warpage can be common in one or two doors within a newly installed kitchen, any door that has not been through a complete heating and cooling cycle has the possibility of warping. Slight warpage can be eliminated through hinge adjustments. Any warping that continues to occur should be further examined by removing the door from the cabinet and placing it on a flat surface. Hinge spacers are available through your authorized Choice Cabinet dealer in cases where the warpage cannot be eliminated through hinge adjustments. If warping cannot be eliminated through hinge adjustments or the use of hinge spacers, and if the doors have been through a complete heating and cooling cycle, and if all of the cabinets are true and plumb; then Choice Cabinet will consider replacement.

As mentioned above, normal movement in wood products is typical. In addition to issues listed above, climate conditions can cause finish breaks, recesses, and joint/panel lines. An open joint line is not considered a defect and is not covered under this warranty.

IV. PRODUCT REPAIR OR REPLACEMENT

Throughout the duration of the warranty period, Choice Cabinet's sole obligation is to repair or replace any defective product at no charge. This warranty only applies to cabinets and affiliated products sold by Choice Cabinet offered through an authorized Choice Cabinet dealer. In the event that a claim is filed after the original product has been discontinued or canceled, Choice Cabinet will honor the warranty, at its discretion, subject to the availability of the product, by either:

Repairing or replacing the defective product with a new product of the same style

OR

Repairing or replacing the defective product with a product of equal value and complementary style in order to maintain the appearance of the original cabinetry purchase.

An exact match between the finish of the original purchased product and the replacement or repaired product is not guaranteed.

V. RIGHTS OF CONSUMER

There are no other warranties, disclosed or indicated, associated with this product. This document serves as a description of the consumer's definitive legal rights within the transaction and is the exclusive warranty of Choice Cabinet. The exclusion or partial limitation of contingent or substantial damages is not permissible in some states. The consumer may also have further rights from state-to-state which are not cited in this warranty.

VI. SUBMISSION OF A CLAIM

All claims must be submitted to the authorized Choice Cabinet dealer where the cabinets were originally purchased. Claims are to be submitted in writing. Every claim must include a dated copy of the original sales receipt as proof of purchase. Unless and until the product is specifically requested by the Choice Cabinet Claims Department, please do not send the defective item(s).



1-YEAR LIMITED WARRANTY

I. DESCRIPTION OF WARRANTY

This warranty applies only to the original purchaser and is not transferable. From the time of purchase, Choice Cabinet offers a One Year Limited Warranty on all of its cabinetry. In addition to cabinetry, all drawers, shelves, roll out trays, and mechanical components are covered under the warranty as well. In the event that any Choice Cabinet product fails during the course of normal use, Choice Cabinet, at its discretion, will either repair or replace the defective product.

Whether the work was performed by a contractor, Choice Cabinet authorized dealer, or yourself; any expenses involved in the shipping, removal, installation, or consequent damage of the defective product is not covered under this warranty. This warranty does not apply to products installed in mobile homes or recreational vehicles.

II. INTENDED USE OF PRODUCT

To be covered by this warranty, the product must be Use only for its intended purpose(s). Cabinets that have been improperly stored, installed, misused, modified, mishandled, and/or subject to excessive moisture or extreme temperature and humidity levels are not covered under this warranty. In addition, any damage caused by smoking and/or environmental/chemical effects are also not covered under this warranty.

III. ANTICIPATED VARIANCE IN PRODUCT

The Choice Cabinet warranty only applies to product defects and does not apply to properties of natural wood that are inherent in natural wood species. Any time you have a natural wood product, occurrences such as pinholes, knots, and variances in color or grain are normal and are not covered under this warranty.

Because half of the weight of freshly cut wood is water, its natural properties are such that they can react to climate and/or humidity changes in your home. Choice Cabinet doors and face frames are manufactured from solid wood that has been carefully kiln-dried, retaining just enough moisture for proper construction and finishing. These hardwoods continue to react to their surroundings long after the manufacturing process has been completed. When wood cabinet doors are in a warm, moist environment (high humidity), the wood expands. In a dry, colder environment (low humidity), the wood will contract. Even with humidity regulation, this phenomenon can be controlled, but it can never be completely eliminated.

Door panels may also be prone to this minor expansion and contraction as seasonal temperature and humidity changes occur in your home. The contraction (shrinkage) of the center door panel during periods of low humidity may result in the appearance of an unfinished line along the edge of the center panel. Choice Cabinet does not consider the appearance of this line as a defect and will not replace doors due to this situation. Touch-up markers are made available to cover this edge line. The installation of a humidity control system is recommended to reduce the possibility of expansion and contraction in wood products.

All Choice Cabinet doors are manufactured in moisture-controlled environments under precise specifications. Although slight door warping can be common in one or two doors within a newly installed kitchen, any door that has not been through a complete heating and cooling cycle has the possibility of warping. Slight warping can be eliminated through hinge adjustments. Any warping that continues to occur should be further examined by removing the door from the cabinet and placing it on a flat surface. Hinge spacers are available through your authorized Choice Cabinet dealer in cases where the warping cannot be eliminated through hinge adjustments. If warping cannot be eliminated through hinge adjustments or the use of hinge spacers, and if the doors have been through a complete heating and cooling cycle, and if all of the cabinets are true and plumb; then Choice Cabinet will consider replacement.

As mentioned above, normal movement in wood products is typical. In addition to issues listed above, climate conditions can cause finish breaks, recesses, and joint/panel lines. An open joint line is not considered a defect and is not covered under this warranty.

IV. PRODUCT REPAIR OR REPLACEMENT

Throughout the duration of the warranty period, Choice Cabinet's sole obligation is to repair or replace any defective product at no charge. This warranty only applies to cabinets and affiliated products sold by Choice Cabinet offered through an authorized Choice Cabinet dealer. In the event that a claim is filed after the original product has been discontinued or canceled, Choice Cabinet will honor the warranty, at its discretion, subject to the availability of the product, by either:

Repairing or replacing the defective product with a new product of the same style

OR

Repairing or replacing the defective product with a product of equal value and complementary style in order to maintain the appearance of the original cabinetry purchase.

An exact match between the finish of the original purchased product and the replacement or repaired product is not guaranteed.

V. RIGHTS OF CONSUMER

There are no other warranties, disclosed or indicated, associated with this product. This document serves as a description of the consumer's definitive legal rights within the transaction and is the exclusive warranty of Choice Cabinet. The exclusion or partial limitation of contingent or substantial damages is not permissible in some states. The consumer may also have further rights from state-to-state, which are not cited in this warranty.

VI. SUBMISSION OF A CLAIM

All claims must be submitted to the authorized Choice Cabinet dealer where the cabinets were originally purchased. Claims are to be submitted in writing. Every claim must include a dated copy of the original sales receipt as proof of purchase. Unless and until the product is specifically requested by the Choice Cabinet Claims Department, please do not send the defective item(s).

For more details, inspiration, and the latest updates, visit us online to explore our full product line, download helpful resources, and browse our gallery for creative design ideas.

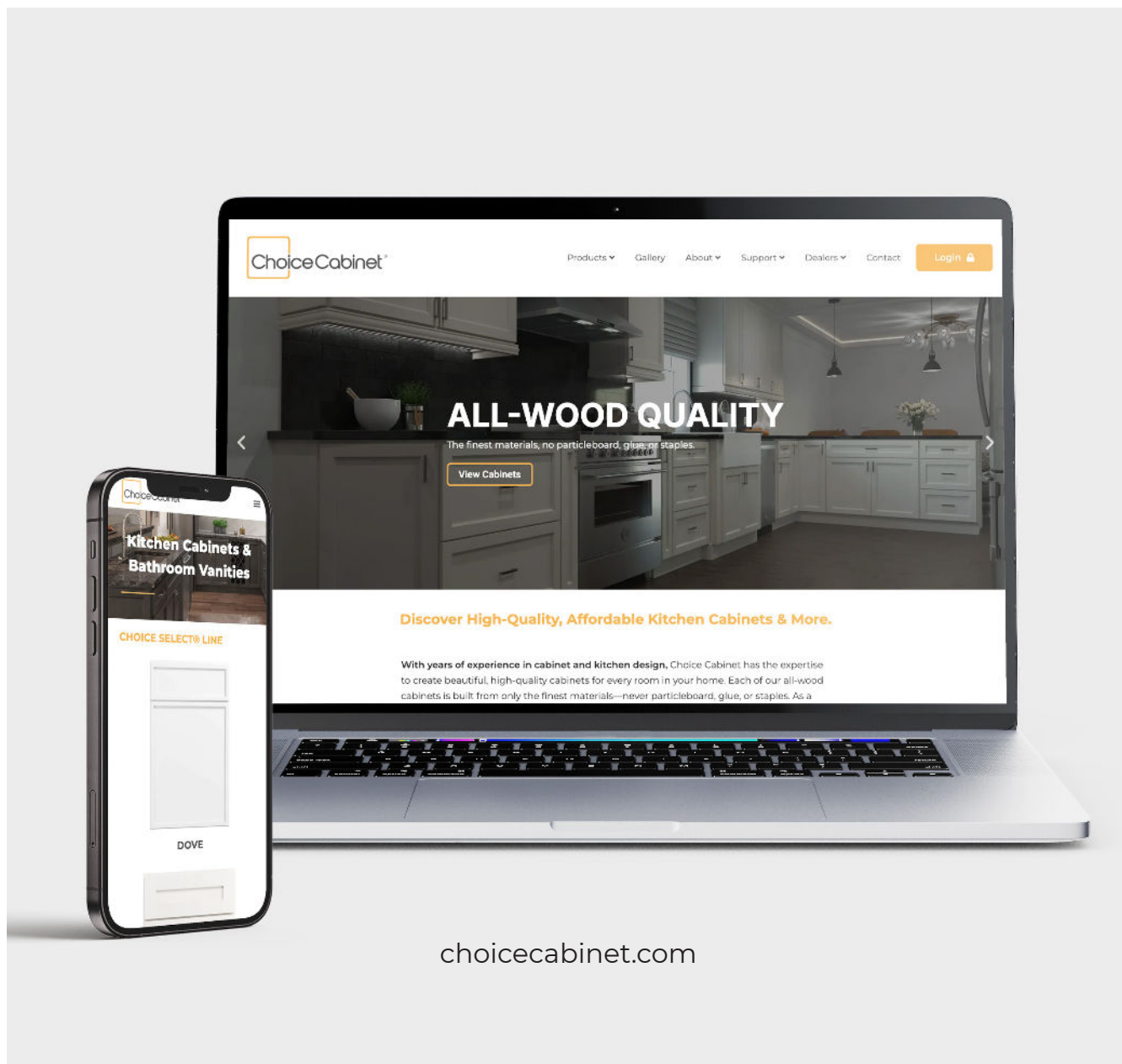

See everything we have to offer online:

- Product details and specifications
- Inspiration gallery
- Frequently asked questions
- Resource and warranty information
- How to become a dealer
- Access to SuiteCommerce



HEADQUARTERS
& WAREHOUSE

ABOUT CHOICE CABINET

Founded in 2006, Choice Cabinet has become one of the nation's fastest-growing cabinet manufacturers. The company has expanded steadily over the years, building a strong national presence, establishing long-term partnerships, and serving hundreds of accounts across the country. Known for its focus on quality and consistency, Choice Cabinet continues to grow as a trusted name in the industry.

HEADQUARTERS & WAREHOUSE

5260 Naiman Pkwy.,
Solon, OH 44139

T: 216.378.2828

F: 216.378.2844



choicecabinet.com



The Choice Professionals Trust.

choicecabinet.com



MKT SPECIFICATION GUIDE
© 2026 Choice Cabinet
All rights reserved.
MAR 2026 Revision